

COBHAM

SAILOR 6216 VHF DSC

User and installation manual



SAILOR 6216 VHF DSC

User and installation manual

Document number: 98-128825-THR-F

Release date: October 16, 2013

Disclaimer

Any responsibility or liability for loss or damage in connection with the use of this product and the accompanying documentation is disclaimed by Thrane & Thrane A/S. The information in this manual is provided for information purposes only, is subject to change without notice and may contain errors or inaccuracies. Manuals issued by Thrane & Thrane A/S are periodically revised and updated. Anyone relying on this information should acquire the most current version e.g. from www.cobham.com/satcom or from the distributor. Thrane & Thrane A/S is not responsible for the content or accuracy of any translations or reproductions, in whole or in part, of this manual from any other source.

Thrane & Thrane A/S is trading as Cobham SATCOM.

Copyright

© 2013 Thrane & Thran3 A/S. All rights reserved. Printed in Denmark.

Trademark Acknowledgements

- **SAILOR** is a registered trademarks of Thrane & Thrane A/S.
- Other product and company names mentioned in this manual may be trademarks or trade names of their respective owners.

Safety warning

The following general safety precautions must be observed during all phases of operation, service and repair of this equipment. Failure to comply with these precautions or with specific warnings elsewhere in this manual violates safety standards of design, manufacture and intended use of the equipment. Thrane & Thrane assumes no liability for the customer's failure to comply with these requirements.

Warranty limitation

IMPORTANT - The radio is a sealed waterproof unit (classified IPX8). To create and maintain its waterproof integrity it was assembled in a controlled environment using special equipment. The radio is not a user maintainable unit, and under no circumstances should the unit be opened except by authorized personnel. Unauthorized opening of the unit will invalidate the warranty.

Installation and service

Installation and general service must be done by skilled service personnel.

Emergency calls



Lift Cover

Press **RED Button**

until acoustic and light-indication becomes steady (more than 3 seconds)

Make sure your VHF Radio is on **CH16**



Use the **HANDMICROPHONE** for voice calling

<p>MAYDAY-MAYDAY-MAYDAY This is NAME-NAME-NAME CALLSIGN or other IDENTIFICATION MMSI (If the initial alert is sent by DSC)</p>	<p>OWN ID</p> <p>SHIP's NAME: _ _ _ _ _</p> <p>CALLSIGN: _ _ _ _ _</p> <p>MMSI: _ _ _ _ _</p>
<p>↓</p>	
<p>MAYDAY NAME of the VESSEL in distress CALLSIGN or other IDENTIFICATION MMSI (If the initial alert is sent by DSC) POSITION given as latitude and longitude or If latitude and longitude are not known or if time is insufficient, in relation to a known geographical location NATURE of distress Kind of ASSISTANCE required Any other useful INFORMATION</p>	

99-129558

Training information

The SAILOR 6216 VHF DSC is designed for "occupational use only" and is also classified as such. It must be operated by licensed personnel only. It must only be used in the course of employment by individuals aware of both the hazards as well as the way to minimize those hazards

The radio is thus NOT intended for use in an uncontrolled environment by general public. The SAILOR 6216 VHF DSC has been tested and complies with the FCC RF exposure limits for "Occupational Use Only". The radio also complies with the following guidelines and standards regarding RF energy and electromagnetic energy levels including the recommended levels for human exposure:

- FCC OET Bulletin 65 Supplement C, evaluating compliance with FCC guidelines for human exposure to radio frequency electromagnetic fields.
- American National Standards Institute (C95.1) IEEE standard for safety levels with respect to human exposure to radio frequency electromagnetic fields, 3 kHz to 300 GHz
- American National Standards Institute (C95.3) IEEE recommended practice for the measurement of potentially hazardous electromagnetic fields - RF and microwaves.

Below the RF exposure hazards and instructions in safe operation of the radio within the FCC RF exposure limits established for it are described.

Warning

Your Thrane & Thrane radio set generates electromagnetic RF (radio frequency) energy when it is transmitting. To ensure that you and those around you are not exposed to excessive amounts of that energy (beyond FCC allowable limits for occupational use) and thus to avoid health hazards from excessive exposure to RF energy, FCC OET bulletin 65 establishes an Maximum Permissible Exposure (MPE) radius of 3 ft (0.9m) for the maximum power of your radio (25W

selected) with an half wave omni-directional antenna having a maximum gain of 3 dB (5.2dBi). This means all persons must be at least 3 ft (0.9m) away from the antenna when the radio is transmitting.

Installation

1. An omni-directional antenna with a maximum power gain of 5.2 dBi must be mounted at least 9.6 ft (2.9m) above the highest deck where people may be staying during radio transmissions. The distance is to be measured vertically from the lowest point of the antenna. This provides the minimum separation distance which is in compliance with RF exposure requirements and is based on the MPE radius of 3 ft (0,9m) plus the 6.6 ft (2m) height of an adult.
2. On vessels that cannot fulfil requirements in item 1, the antenna must be mounted so that its lowest point is at least 3 ft (0.9m) vertically above the heads of people on deck and all persons must be outside the 3 ft (0.9m) MPE radius during radio transmission.
 - Always mount the antenna at least 3ft (0.9m) from possible human access.
 - Never touch the antenna when transmitting
 - Use only authorized T&T accessories.
3. If antenna has to be placed in public areas or near people with no awareness of the radio transmission, the antenna must be placed at a distance not less than 6 ft (1.8m) from possible human access.

Failure to observe any of these warnings may cause you or other people to exceed FCC RF exposure limits or create other dangerous conditions

Manual overview

This manual has the following chapters:

- *Introduction* contains a description of the VHF radio.
- *Operation* explains how to make and receive voice and DSC calls over VHF, including how to use and set-up the channel scanning, the 2-way loudhailer, fog horn external loudspeaker.
- *Installation* explains how to mount the VHF radio and how to connect accessories and external equipment.
- *Service & maintenance* contains support information including lists of accessories and a troubleshooting guide.

Table of Contents

Chapter 1	Introduction	
	VHF radio with DSC	1
Chapter 2	Operation	
	General use and navigation	6
	VHF radio communication	12
	HI/LO transmission power	17
	Watch	18
	Scan	19
	Radio setup	21
	DSC calls	24
	Phone book	41
	Loudhailer with talk-back	44
	Automatic foghorn	45
	Hailer and Fog horn setup	47
	Replay function	48
Chapter 3	Installation	
	Unpacking the SAILOR 6216 VHF DSC	49
	Installing the VHF radio	50
	Power, VHF antenna and external equipment	57
	System setup	64
	SAILOR 6201 Handset cradle (optional)	65

Chapter 4	Service & maintenance	
	Contact for support	67
	Maintenance	67
	Equipment and accessories	74
	Warranty	74
App. A	Technical specifications	
App. B	Maritime channels	
Glossary	83
Index	85

Introduction

VHF radio with DSC

SAILOR 6216 VHF DSC, your new SAILOR VHF radio with full DSC functionality, is approved to FCC and Industry Canada and is waterproof to the IPx8 and IPx6 standard. As part of the required safety equipment, use the SAILOR 6216 VHF DSC in an emergency situation. However the best way to guarantee functionality in an emergency situation, is to use the radio in daily communication on board.



The VHF radio is a simplex/semi duplex VHF radio. It is designed with an easy-to-use menu-driven setup. You use the soft-keys to enter the desired functions, you browse and select a setting using the right selection wheel knob. The large display has red adjustable backlight which provides a good visibility even at night and protects your night vision.

The VHF radio can replay the last 90 s of received voice. This is a useful feature to minimize misunderstandings and to record messages when the radio is unattended.

The VHF radio connects easily to external equipment like a 2-way loudhailer and an external speaker. You can use the loudhailer as a 2-way on-board communicator. The loudhailer also functions as a fog horn. You can select from several programmed fog-horn patterns.

For a list of other accessories available for the SAILOR 6216 VHF DSC check with your nearest distributor.

Controls on the front plate

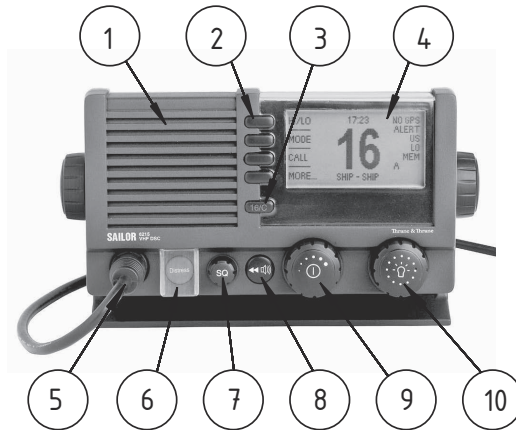

1. Loudspeaker.
2. Four soft keys with function title in the display.
3. Quick selection key for channel 16 and the programmed call channel.
4. Large display.
5. Connector for Handmicrophone or handset. If not used, put the cap from the ACC connector on the front connector to prevent water ingress.
6. Button for sending a DSC Distress alert.
7. Squelch control to mute background noise.
8. Replay button to play back up to 90 s voice message.
9. Volume wheel knob with key-press function for volume control and power on/off.
10. Selector wheel knob with key-press function for changing the working channel, navigating in menus in the display and backlight dimming.

SAILOR 6216 VHF DSC display

The picture shows the display after start-up. The display holds various fields of information, depending on the currently selected function.

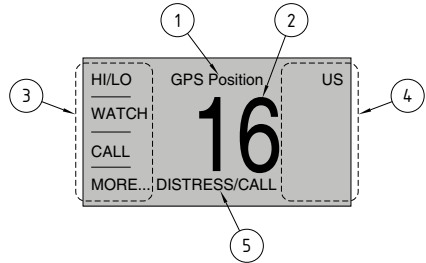

1. **Action line** containing information relevant for the currently selected function.
2. Current working channel.
3. Functions you can select with the soft keys. If there are more than 4 functions in the list press the soft key **MORE** to display further functions.
4. Status and other values for the current state or VHF channel.
5. **Service line** containing current temporary information relevant for the current channel or function.

For a detailed description of the information shown for each of the functions available see the chapter *Operation* on page 5.

System configuration - example

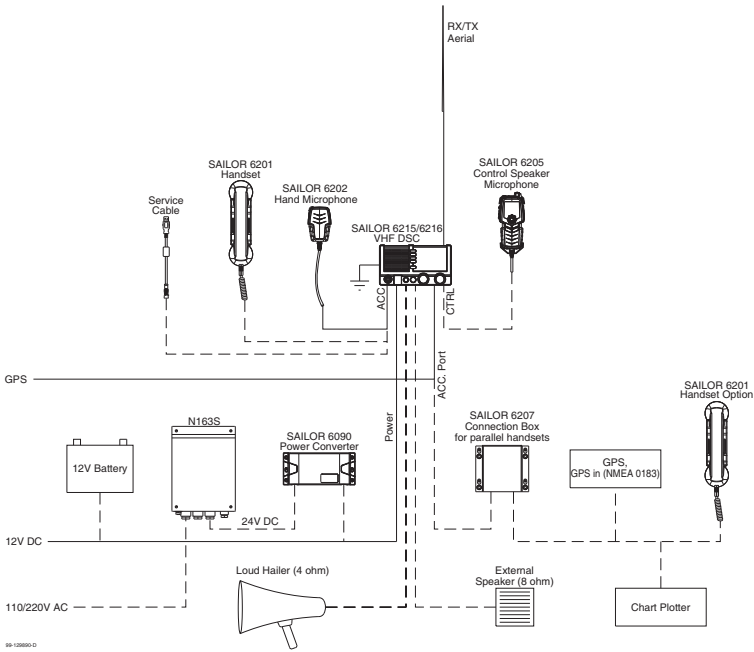

Operation

Note

Before using the VHF radio make sure that the VHF antenna, power and other external equipment are connected properly. For instructions see chapter *Installation* on page 49.

In this chapter you find detailed instructions and guidelines for:

- *General use and navigation*
- *VHF radio communication*
- *HI/LO transmission power*
- *Watch*
- *Scan*
- *Radio setup*
- *DSC calls*
- *Phone book*
- *Loudhailer with talk-back*
- *Automatic foghorn*
- *Replay function*

General use and navigation

Power on and speaker volume

The VHF radio has a dual-function on/off wheel knob for power on/off and volume control.

- To power on the VHF radio press the on/off wheel knob.
- To power off the VHF radio, press and hold the on/off wheel knob and follow the instructions in the display.
- To adjust the speaker volume, turn the volume wheel knob (clockwise = louder, counter clockwise = softer, until muted). When adjusted to the muted level  is shown in the display.



Working channel, settings and dim function

The selector wheel knob has several functions:

- To select the **working channel**, turn the selector wheel knob.
- To browse and select **settings**, turn the selector wheel knob and press for accept.
- To **dim the backlight** in the display until it is appropriate for the current situation, i.e. to give comfortable night vision, press, hold and turn the selector wheel knob (clockwise= more light).



DSC and MMSI number

When the VHF radio is powered on for the first time, you must enter the vessel's MMSI number. Hereafter the MMSI number is briefly displayed after power up. The MMSI is a unique, 9-digit identifier assigned to your ship.

Important

The MMSI number must be programmed into the VHF radio to use any DSC functionality. The radio will prompt for the MMSI number at each power-up until the MMSI has been entered. An error message is displayed when trying to initiate any DSC function. However, you can use the radio in normal VHF mode.



Caution! Without a programmed MMSI number the Distress button will not work!

Entering the MMSI number

When being prompted after power up enter the MMSI number as described below:

1. Enter the 9 digits one by one by turning the selector wheel knob to the desired digit, press the selector wheel knob to accept the digit and advance to the next digit.

To delete the previous digit press the soft key **BACK**.

2. Press the soft key **OK** to confirm the entered MMSI number.
3. To leave without saving, press the soft key **CANCEL**.

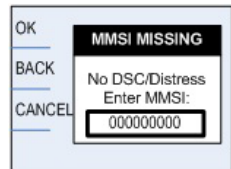

Note

The MMSI number can be programmed by the operator once. If a wrong number has been entered and stored, or if there is a requirement to change it, contact your authorized dealer.

Once programmed, you can see the MMSI number in the service line directly after start-up. The DSC functionality is operational at any time.

The message **NO DSC (NO MMSI)** is shown in the action line if the MMSI is not programmed.

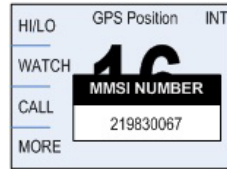

Position and MMSI Information

To display position and MMSI information for the SAILOR 6216 VHF DSC radio, do as follows:

1. Press the soft key **POS**. If it is not in the display, press the soft key **MORE** until **POS** appears.
The display shows the current (latest) position (if a GPS is connected), the UTC and position type, GPS Status and MMSI.
2. You can enter the position and UTC manually. Turn the selector wheel knob to select the value you want to change. Then press and turn the selector wheel knob to enter the current position or UTC time. The display shows **Man Position**.
3. Press the soft key **SAVE** to save the new value.
4. After you have entered a value manually or overruled the GPS input, a soft key **UseGPS** appears in the display if the GPS is available. Press this soft key if you decide to use the data from the connected GPS.
5. Press the soft key **EXIT** to return to normal use.

If the GPS was present and then disappears a warning appears in the display after 10 minutes. Follow the instructions on the screen.

Speaker devices

The VHF radio can be equipped with the following speaking devices:

- SAILOR 6202 Handmicrophone with a PTT (Push To Talk) button.
- Handset with a microphone, ear piece and a PTT button. The volume in the ear piece can be adjusted, for details see *Controller setup* on page 10.
- Loudhailer.
- External speaker.

See *Controller setup* on page 10 for managing speaking devices.

Adjusting the squelch

With the Squelch control you can manually adjust and suppress noise in order to optimize the quality of the received radio communication.



- When hearing noise or an unwanted signal, turn the squelch button clockwise until the speaker is muted.

Functions

The following functions are available from top-level standby:

Soft key	Function
HI/LO	Transmitter power, high or low
WATCH	Dual or triple watch
CALL	DSC calls
POS	Current position from GPS, including UTC time and MMSI number
ALERT	Make a distress call, categories can be assigned
SCAN	Scanning function

Soft key	Function
HAIL	Loudhailer
FOG	Fog horn
PHBOOK	Phone book
SETUP	Setup pages for RADIO, HAILER/FOG, SYSTEM, CONTROLLER and DSC

The functions of the SAILOR 6216 VHF DSC are accessed and set using the four soft keys to the left of the display. The current function of a soft key is shown in the display next to the soft key.



For some applications there are two control levels

- A **top level** showing the current information and options for this application. This can be on one page, or on several pages.
- A **setup screen** showing the options you can configure for the specific application.

Use the soft key **MORE** to display further applications.

Controller setup

In the CONTROLLER SETUP you set handset volume, external speakers and display contrast. You can view the Software version and serial number.

To change a setting in the **CONTROLLER SETUP**, do as follows:

1. Press the soft key **SETUP**. If it is not in the display, press the soft key **MORE** until **SETUP** appears.
2. Press the arrow soft key **➡** or **⬅** to advance to **CONTROLLER SETUP**.

3. Turn the selector wheel knob to go to a setting, then press the selector wheel knob to change the setting.
4. Press **EXIT** to return to normal radio operation.



Parameter	Description
Handset 1 vol:	Adjust earpiece volume for handset 1: OFF, 1 to 14 Note: Default setting is OFF. If a handset is connected to the front connector this value must be configured to a value (1-14).
Handset 2 vol:	Adjust earpiece volume for handset 2: OFF, 1 to 14 Note: Default setting is OFF. If a handset is connected to the rear connector this value must be configured to a value (1-14).
Ext. speaker	FIX: Fixed level is set for external speaker REL: Relative level following volume adjustment of the internal speaker
Ext. fix/rel vol:	External speaker fix or rel volume: rel: -5 to 5. Offset relative to internal speaker steps fix: OFF, 1 to 14
Language	English
Contrast	Display contrast, 1 to 5

VHF radio communication

In this section of the manual you find information on

- *Basic VHF operation*
- *VHF channels*
- *Programming a call channel*
- *Naming a channel*

Basic VHF operation

You can make VHF calls using the Handmicrophone or another speaking device.

Note

A single, short press on the **16/C** key will always bring you to **channel 16**, the international calling and distress channel, no matter what menu the radio is in.

A black rounded rectangular button with the white text "16/C" inside.

Quick guide to radio telephone calls

1. Press the **PTT** button on the speaking device. When the TX indicator lights up in the display, the transmission is active.
2. To enable reception of a radio signal release the **PTT** button.



Note

Press **PTT** only when you are talking. Always say “Over.” just before releasing the PTT button.

Note

One transmission is limited to **5 minutes** duration.

Receiving a radio telephone call on channel 16

When you hear your call name in the loudspeaker, proceed as follows:

1. An RX symbol shows that the radio is receiving on the channel displayed.
2. Lift the Handmicrophone or take the handset.
3. Press the **PTT** key. A TX symbol shows that the radio is transmitting on the channel displayed.
4. Repeat the name of the station calling you and say: "This is [your ship's name]".
5. Suggest a working channel other than 16 by saying: "Channel [suggested channel number]".
6. Say: "Over." and release the **PTT** key to allow the caller to confirm the suggested new channel.
7. Switch to the new channel by turning the selector wheel knob to the agreed channel and begin your conversation. Press **PTT** only when you are talking.

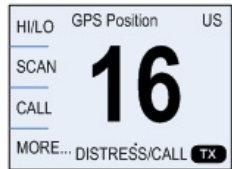
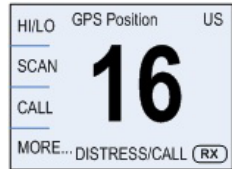

Making a radio telephone call on channel 16

To make a radio telephone call, proceed as follows:

1. Select channel 16 by pressing the soft key **16/C** or by turning the selector wheel knob.
2. Lift the handset or take the Handmicrophone.
3. Press the **PTT** key. A TX symbol shows that the VHF radio is transmitting on the working channel displayed.
4. Say the name of the station you are calling three times.
5. Say: "This is [your ship's name]".

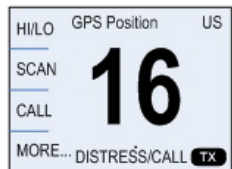

6. Say: “Over.” and release the PTT key to listen. An RX symbol shows that the radio is receiving on the working channel displayed
7. When answered, agree upon a working channel other than 16.
8. Switch to the new channel by turning the selector wheel knob to the agreed channel and begin your conversation.

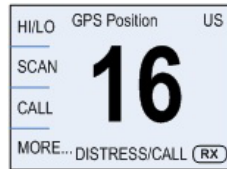

VHF channels

You can change channels whenever the channel designator is displayed. Turn the selector wheel knob to browse through all channels that are available in the selected channel mode. The channels appear in the display in the following order:

- Primary channels
- Weather channels (if any)
- Private channels (if any)

To quickly toggle between these 3 channel groups make a long press and release the selector wheel knob. The VHF radio toggles between the last selected channels in the respective groups, i.e. the last selected weather channel, the last selected private channel or the last selected primary channel. If there are no channels defined in a group, none will be selected.

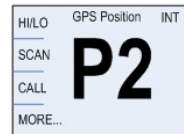
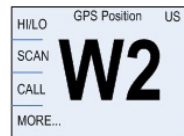

VHF channel table	Description
Primary channels (no prefix)	For details see <i>Maritime channels</i> on page 79. For instructions how to change a channel table see <i>Radio setup</i> on page 21.
Weather (WX)	Weather channels have the prefix W . (For US and CA channels only.)
Private (PRIV)	Up to 40 user-defined private channels. Contact your dealer for programming private channels.

Programming a call channel

To program a call channel (or quick selection), do as follows:

1. Make an extra-long press (2.5 s duration) on the **16/C** key.
2. Press the soft key **CALL CH**. The channel designator is flashing.
3. Turn the selector wheel knob to select the desired channel.
4. Press the soft key **OK** to confirm the new call channel and leave edit mode.



Naming a channel

To name a channel, do as follows:

1. Make an extra long press on the **16/C** key until **NAME** is shown in the display next to one of the soft keys.
2. Turn the selector wheel knob to select the channel you want to name.
3. Press the soft key **NAME**.
4. Turn and press the selector wheel knob to enter the name, letter by letter. Press **BACK** to move one character to the left. Press **CLEAR** to delete the current character and the following characters. A long press on **CLEAR** deletes all characters.
5. Press the soft key **OK** to confirm the entered value and to leave edit mode.
6. Press **EXIT** to return to return to the standard VHF display.



Display for non-VHF applications

When the radio is used for functions other than VHF, the display is arranged differently. The large channel display moves to the bottom line along with selected icons.

The channel displayed in this line will always reflect the communication channel on which the radio is tuned into for communication.

If **PTT** is pressed the radio transmits on the displayed channel (not valid for hailer mode).

If a signal is received the signal is received on the displayed channel.

Engagement status



The radio is considered engaged when an active DSC-initiated communication is ongoing, or communication is active on non-DSC initiated VHF operation:

- A new channel selected
- PTT pressed or,
- Voice signal received

The engagement state is used to prohibit incoming DSC calls from taking over control of the transmitter channel, disrupting ongoing communication.

When the radio is engaged in VHF communication not initiated by DSC, this is indicated with the icon  in the lower right position of the display. Engagement will automatically time-out on inactivity (in the absence of any of the listed events above), and after an inactivity time specified in DSC setup, Comm Inactivity on page 39.

To terminate the engagement immediately press the soft key .

Before the automatic disengagement, the icon  will flash. To prolong the engagement press the soft key .

HI/LO transmission power

Press the soft key **HI/LO** to toggle the transmit power between low (1 W) and high (25 W). If **LO** is not displayed, the transmit power is HI.

US channels: Local mode, 10 dB attenuation

To attenuate to the incoming signal, do as follows:

1. Press the soft key **LOCAL** to add 10 dB attenuation. If it is not in the display, press the soft key **MORE** until **LOCAL** appears in the display.

Note

Local mode is automatically exited when using channel 16. If you want to use attenuation on channel 16 or a call channel, you must set it manually each time.

US channels: Overriding LOW power for channels 13 and 67

When running in US mode you can override low power on the alternative call channels 13 and 67. Do as follows:

1. With the VHF radio set to 13 and 67, press **PTT** on the speaking device.
2. Press the soft key **OVERRIDE** to transmit with full power.

When you release the **PTT** button, the transmission power goes back to low.

Watch

The SAILOR 6216 VHF DSC radio can be set to dual watch or triple watch. In dual watch, the working channel and channel 16 are watched. In triple watch the working channel, channel 16 and the programmed call channel are watched.

You can select the working channel in any watch mode by turning the selector wheel knob. The working channel that is displayed is the channel used for dual or triple watch. If there is a signal in one of the watched channels and squelch opens, the display shows the channel in which the signal is received.

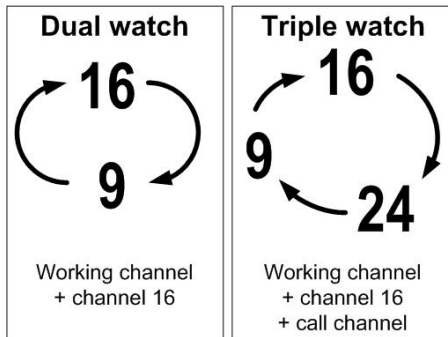

Note

If PTT is operated during any watch mode, the **WATCH** function is terminated and you transmit on the displayed channel. Watch mode may be resumed after releasing the **PTT** button if the scan resume time is set up in **SETUP**, for instructions see *Radio setup* on page 21.

Using WATCH

1. To start watch press the soft key **WATCH**. The radio enters the last watch mode. It is displayed in the action line.
2. To stop **WATCH** press **WATCH** again, or press **PTT** on the speaking device.



For instructions how to change between **DUAL** and **TRIPLE WATCH** see *Radio setup* on page 21.

Scan

The radio has a scanning function for tagged channels. Any available channel, including weather and private channels, can be tagged and added to the scanning sequence. As default the radio scans with priority scanning of channel 16. If a signal is received while in any scanning mode, only channel 16 continues to be watched.

If there is a signal in one of the scanned channels, the display shows the channel in which the signal is received. Pressing PTT while a signal is received stops scanning and the radio is tuned into the displayed channel.

Using SCAN

1. To start scanning press the soft key **SCAN**. The SCAN menu is shown. Press **START** to start scanning.
2. To stop **SCAN** press **SC STOP**, or press **PTT** on the speaking device.
3. To tag a channel in order to include it in the scanning sequence, turn the selector wheel knob until the wanted channel is in the display. Then press the soft key **TAG**. The display shows the channel number and the word **TAG** at the right side of the display.
4. To remove a channel from the scanning sequence, turn the selector wheel knob until the tagged channel is displayed. Then press the soft key **TAG** to remove the tag.

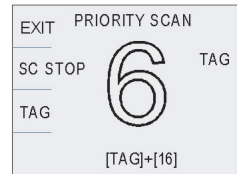

When scanning is activated the working channel is displayed in a different format (open, outline typeface). This indicates the radio is not tuned into the displayed channel. The displayed working channel is temporarily included in the scanning list (although no TAG icon is shown).

If PTT is pressed while scanning, the scanning is stopped and transmission starts immediately on the displayed working channel.

US channels: Watch alarms for NOAA Weather alerts

Note

NOAA weather channels are available in the waters of USA and Canada only.

You can turn on or off an independent watch alarm for a specific weather channel.

To turn on or off an independent NOAA weather alarm do as follows:

1. In the **SCAN** menu, turn the selector wheel knob to select a specific weather channel.
2. Press the soft key **WX** to tag this weather channel for NOAA weather alert.
3. On the display you can see that the selected weather channel alert watch is enabled. In this example it is [W2].

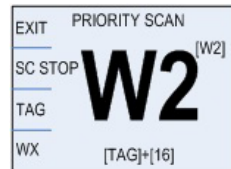

3. The weather channel set-up for the alarm is scanned frequently during scanning, watch or when the radio is not operated or receiving on a working channel.
4. If a NOAA weather alert is detected on a weather channel, beep tones are presented and a pop-up window is displayed. Press **YES** to switch to the weather channel.

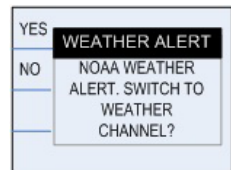

Radio setup

In the RADIO SETUP you set scan and watch mode, select the channel table and can set and view the ATIS code. To change a setting in the **RADIO SETUP**, do as follows:

1. Press the soft key **SETUP**. If it is not in the display, press the soft key **MORE** until **SETUP** appears.
2. Press the arrow soft key **➡** or **⬅** to advance to **RADIO SETUP**.
3. Turn the selector wheel knob to go to a setting, then press the selector wheel knob to change the setting.
4. Press **EXIT** to return to normal radio operation.

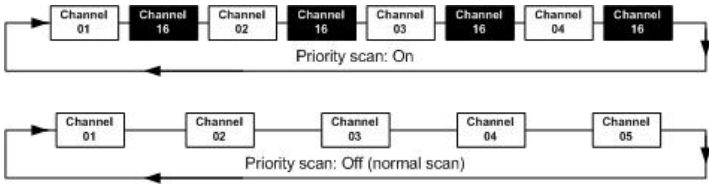

Parameter	Description
Scan Hang Time	Scan hang time, in seconds on an active receiving working channel. The time is measured from the signal is detected. The radio remains on the channel for the set time interval, if a signal was detected. OFF : Resumes scanning when signal disappears (default) 4, 6, 8, 10 : Hang time in seconds.
Scan/watch Resume	Scan resume time, in seconds. When the programmed time of inactivity has elapsed, and when watch/scan has been aborted using a press on PTT, or after power-up, scan or watch is resumed. OFF : Automatic resume is deactivated (default) 3, 6, 10, 15, 20, 25, 30 : Resume time in seconds.
Watch Mode	DUAL : Dual watch monitoring the working channel and the priority channel (channel 16, default for international channels). TRIPLE : Triple watch. The working channel is watched with the priority channel (channel 16) and the programmed call channel (if any, otherwise dual watch).

Parameter	Description
<p>Priority Scan</p>	<p>ON: All channels tagged for scanning are scanned while monitoring channel 16. (default). OFF: Only the channels tagged for scanning are scanned in sequence, not channel 16, unless it is tagged for scanning.</p> 
<p>Channel Mode</p>	<p>To select the channel table for the primary channel. Channel tables available: US, CAN, ALT, PRIV, See also <i>VHF channel table</i> on page 14.</p>
<p>Bandwidth</p>	<p>Selection of the bandwidth for the fixed pre-programmed channels. This is recommended from Radio Regulations:</p> <p>Wide: Wide band is 25kHz channel bandwidth (default) Narrow: Narrow band defines a channel bandwidth of 12.5kHz</p>

Parameter	Description																																																																																				
ATIS code	<p>The ATIS code (Automatic Transmitter Identification System) is used for identification to marine coast and inland stations and its use is mandatory in a number of European inland waterways such as e.g. the river Rhine.</p> <p>Like the MMSI number the ATIS number is issued by the relevant authority.</p> <p>Enter the format of the programmed ATIS code according to the following call sign prefix conversion table:</p> <table border="1" data-bbox="292 592 988 866"> <thead> <tr> <th>Character</th> <th>Phonetic</th> <th>Value</th> <th>Character</th> <th>Phonetic</th> <th>Value</th> </tr> </thead> <tbody> <tr><td>A</td><td>Alpha</td><td>1</td><td>N</td><td>November</td><td>14</td></tr> <tr><td>B</td><td>Bravo</td><td>2</td><td>O</td><td>Oskar</td><td>15</td></tr> <tr><td>C</td><td>Charlie</td><td>3</td><td>P</td><td>Papa</td><td>16</td></tr> <tr><td>D</td><td>Delta</td><td>4</td><td>Q</td><td>Quebec</td><td>17</td></tr> <tr><td>E</td><td>Echo</td><td>5</td><td>R</td><td>Romeo</td><td>18</td></tr> <tr><td>F</td><td>Foxtrot</td><td>6</td><td>S</td><td>Sierra</td><td>19</td></tr> <tr><td>G</td><td>Golf</td><td>7</td><td>T</td><td>Tango</td><td>20</td></tr> <tr><td>H</td><td>Hotel</td><td>8</td><td>U</td><td>Uniform</td><td>21</td></tr> <tr><td>I</td><td>India</td><td>9</td><td>V</td><td>Victor</td><td>22</td></tr> <tr><td>J</td><td>Juliett</td><td>10</td><td>W</td><td>Whiskey</td><td>23</td></tr> <tr><td>K</td><td>Kilo</td><td>11</td><td>X</td><td>X-ray</td><td>24</td></tr> <tr><td>L</td><td>Lima</td><td>12</td><td>Y</td><td>Yankee</td><td>25</td></tr> <tr><td>M</td><td>Mike</td><td>13</td><td>Z</td><td>Zulu</td><td>26</td></tr> </tbody> </table> <p>Note: The ATIS number can be programmed by the operator once. If a wrong number has been entered and stored, or if there is a requirement to change it, contact your authorized dealer.</p>	Character	Phonetic	Value	Character	Phonetic	Value	A	Alpha	1	N	November	14	B	Bravo	2	O	Oskar	15	C	Charlie	3	P	Papa	16	D	Delta	4	Q	Quebec	17	E	Echo	5	R	Romeo	18	F	Foxtrot	6	S	Sierra	19	G	Golf	7	T	Tango	20	H	Hotel	8	U	Uniform	21	I	India	9	V	Victor	22	J	Juliett	10	W	Whiskey	23	K	Kilo	11	X	X-ray	24	L	Lima	12	Y	Yankee	25	M	Mike	13	Z	Zulu	26
Character	Phonetic	Value	Character	Phonetic	Value																																																																																
A	Alpha	1	N	November	14																																																																																
B	Bravo	2	O	Oskar	15																																																																																
C	Charlie	3	P	Papa	16																																																																																
D	Delta	4	Q	Quebec	17																																																																																
E	Echo	5	R	Romeo	18																																																																																
F	Foxtrot	6	S	Sierra	19																																																																																
G	Golf	7	T	Tango	20																																																																																
H	Hotel	8	U	Uniform	21																																																																																
I	India	9	V	Victor	22																																																																																
J	Juliett	10	W	Whiskey	23																																																																																
K	Kilo	11	X	X-ray	24																																																																																
L	Lima	12	Y	Yankee	25																																																																																
M	Mike	13	Z	Zulu	26																																																																																

DSC calls

In this section of the manual you find information on:

- *Sending, acknowledging and cancelling own distress*
- *Receiving distress calls*
- *DSC calls for communication*
- *DSC setup*

Sending, acknowledging and cancelling own distress

To send a distress message

To send a distress message do as follows:

1. Lift the cover over the red distress button and press and hold the distress button for longer than 3 seconds. For short step-by-step instructions how to proceed when sending a distress message see *Emergency calls* on page iv.



When the distress signal is sent, **CH70** and **Tx** appear in the display. A 2-second beep tone is heard.

2. The radio watches for a DSC acknowledgement transmission on channel 70.
3. To pause the automatic resend procedure press the soft key **PAUSE**.
4. To annul the distress message press the soft key **ANNUL**. See also *To cancel own distress* on page 27.
5. When a distress acknowledgement is received, start distress communication on channel 16 to inform about your distress situation.

ANNUL	OWN DISTRESS
	WAIT FOR ACK
INFO	ELAPSED TIME: 0:00:10
PAUSE (ACTIVE)	
	REPEAT IN 2:11
MORE	CH: 16

(Example)

Note

If no distress acknowledgement is received within a period of 3,5 to 4 minutes, the distress message will automatically be retransmitted.

Having pressed the red distress button and sent the distress message, press the soft key **INFO** to display further information:

- STATION: shows the radio's MMSI number.
- NAT: shows the nature of distress, see also *To send a distress message with specified nature* on page 25.
- LAT:, LON:, POS UTC: shows the distress position data as transmitted.
- MODE: shows the communication mode.

PAUSE	DISTRESS (DETAIL)
ANNUL	STATION: 123456789
INFO	NAT: UNDESIGNATED
MORE	LAT: 23°23.3234N
	LON: 123°23.3234W
	POS UTC: 12:34
	MODE: TELEPHONY

(Example)

If you sent a distress message, the VHF radio is automatically set to channel 16, the channel reserved for international distress, safety and calling.

To send a distress message with specified nature

When sending distress messages you can include the distress nature in the message. To include the distress nature in the distress message do as follows:

1. From top-level standby press the soft key **ALERT**. If it is not in the display, press the soft key **MORE** until **ALERT** appears.
2. Press the selector wheel knob, then turn it to select among the supported natures of distress:

EXIT	DISTRESS CALL
POS	UNDESIGNATED
	LAT: 23°23.3234N
	LON: 123°23.3234W
	POS UTC: 12:34
	PUSH DISTRESS

FIRE, EXPLOSION	DISABLED (and adrift)
FLOODING	UNDESIGNATED
COLLISION	ABANDONING (ship)
GROUNDING	PIRACY (/armed robbery attack)
LISTING (MAN OVERBOARD
SINKING	

3. Press the selector wheel knob to accept the selected nature of distress.
4. Then lift the cover of the red distress button and push the **Distress button** for 3 seconds.



To acknowledge own distress

When the SAILOR 6216 VHF DSC receives an acknowledgement of distress from another vessel or station, a 2-tone alarm sounds. The display shows the MMSI number of the station who sent the distress acknowledgement call, the status and the time passed since the distress acknowledgement arrived (format: mm:ss).

OK	OWN DISTRESS
	DISTRESS ACKNOWLED.
SILENT	FROM: 002233445
	TO: ALL SHIPS
INFO	DISTR MMSI: 123456789
	NAT: UNDESIGNATED
MORE	LAT: 23°23.3234N

- Press **SILENT** to only switch off the 2-tone alarm. A press on **any other key** also switches off the 2-tone alarm.
- Press the soft key **INFO** to display further data for this call.
- Press the soft key **OK** to view the status of this distress call.

If the same Distress call comes in more than once, the 2-tone alarm sounds briefly and terminates automatically.

QUIT	OWN DISTRESS
	ACKNOWLEDGED
INFO	MMSI: 002233445
	ELAPSED TIME 0:12
ACTIVE	(ACTIVE)
MORE	CH: 16

To cancel own distress

If you need to cancel a sent distress message do as follows:

1. The display shows that a distress message has been sent. Press the soft key **ANNUL**.
2. Press the soft key **YES** to go ahead with the cancelling process. At this stage you have the option to press the soft key **NO** to return to distress sending procedure.
3. The SAILOR 6216 VHF DSC will send the Self-cancellation call on channel 70 and the display automatically shows the message that you should say when cancelling the distress with a radio message.
4. Press the soft key **INFO** to scroll to the next display to proceed with the voice cancel
5. Press the soft key **OK** to go to the acknowledged state. Own distress is cancelled now.

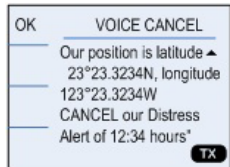
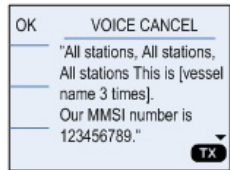
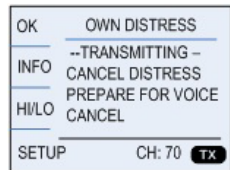
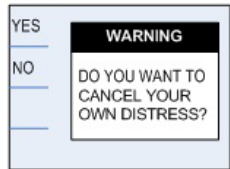
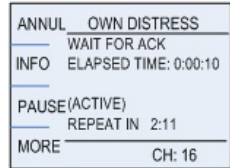

Power failure while in distress

In case of a power failure or switch-off during the transmission of a Distress the SAILOR 6216 VHF DSC gives an audible warning after power-up and automatically resumes sending Distress 10 seconds after power up.

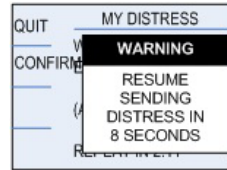

Within the 10 seconds you have the following options:

- Press **QUIT** to terminate the active distress procedure (acknowledged or unacknowledged)
- Press **CONFIRM** (or do nothing) to resume the sending Distress procedure.

Receiving distress calls

When the radio receives a distress call, the 2-tone alarm sounds.

Types of distress calls are DISTRESS, DISTRESS ACK, DISTRESS RELAY and DISTR. RELAY ACK.

1. To switch off the 2-tone alarm press the soft key **SILENT**. A press on **any other key** also switches off the 2-tone alarm.
2. If you decide to stay in the communication loop to receive follow up information, updates etc., press the soft key **OK**.
3. If you don't accept the distress call, press the soft key **CANCEL**, then the radio logs the call.
4. Monitor channel 16 as a coast station may require your assistance. If the radio is not on channel 16, turn the selector wheel knob or use the key **16/C** to go to channel 16.

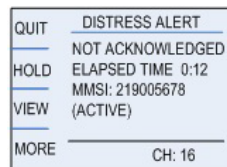
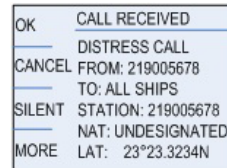

5. The radio receives the first distress acknowledgement call and the 2-tone alarm sounds again. To switch off the 2-tone alarm press the soft key **SILENT**. A press on **any other key** also switches off the 2-tone alarm.any key.

Distress call with errors

If a distress call contains errors, it is still received and errors in the data are shown as underscores (_).



Distress call log

As long as you are part of a distress session, i.e. you have not pressed **QUIT**, you receive distress messages and can track all distress messages for the current distress event.

Do as follows:

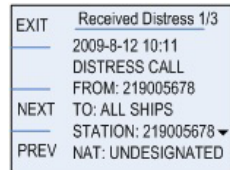

1. Press the soft key **LOG**. If it is not in the display, press the soft key **MORE** until **LOG** appears.
2. Press the soft key **NEXT** and **PREV** to browse the received Distress messages.
3. Press the soft key **EXIT** to leave the log.

DSC calls for communication

With a DSC call you can establish a radio communication with one or several specific radios on a suggested VHF channel.



To make a DSC call for communication, do as follows:

1. Press the soft key **CALL**.

The default call is an individual routine call.

Press and turn the selector wheel knob to enter the 9-digit MMSI number of the vessel you want to contact or use the phone book to select a frequently called contact.

The soft key  is used to toggle between the VHF communication and a DSC session on hold.

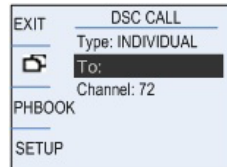

2. Press and turn the selector wheel knob to select other call types or set the details for the call:

- Type:

DSC call type	Category
INDIVIDUAL (default)	Routine (default) or safety calls, calls to a ship or a station
GROUP	Routine
ALL SHIPS	Safety (default) or urgency
SAFETY TEST	Test call, check of safety equipment
POSITION	Routine position request

- Press and turn the selector wheel knob to change the suggested VHF channel for following communication.
3. Press the soft key **SEND** to make the call.

Sessions

A DSC session (or automated procedure) is defined as a collection of DSC calls (transmitted and/or received) that are related to the same event (e.g. a distress event) or established call (e.g. an individual call request followed by an acknowledgement).

A session can be either active or on hold. The active session has control over the radio transmitter.

A session can have a purpose. For example if the purpose is to establish a communication on a working channel.

The non-DSC VHF communication is considered as a session that can be active (engaged) or on hold (dis-engaged). See also *Engagement status* on page 16.

Display for a DSC session

1. Head line showing the type of call that initiated the DSC session, see table below for a list of available head lines.

QUIT	INDIVIDUAL TX	← 1
HOLD	WAIT FOR ACKNOWLEDGE	← 2
	MMSI: 278888913	← 3
	ELAPSED TIME 0:12	← 4
INFO	(ACTIVE)	← 5
	CHANNEL: 15	← 6
MORE	LO CH15 TX	

2. Session status line displays the current state of the session:

- WAIT FOR ACKNOWLEDGE – You made an individual call to a station and are awaiting a reply to establish connection.
- OCCUPIED - The DSC transmission mechanism waits until the DSC channel (70) is free.
- TRANSMITTING - Transmission of a DSC message is ongoing.
- IN COMMUNICATION WITH – The communication has been established.

3. The MMSI number of the other party, if contact to a specific station or group shall be established.

4. Elapsed time since the reception of a call request or an acknowledgement.
5. Session state:
 - (ACTIVE) — transmitter tuned into the communication channel.
 - (HOLD) — parked session.
6. Channel used for following communication (if any) when the session is active.

Headline	Explanation
OWN DISTRESS	The ship is in own distress. See also <i>To send a distress message</i> on page 24.
DISTRESS RX	You watch or participate in a distress communication for another station in distress
RELAY calls (numerous)	You watch or participate in a distress communication for another station in distress
ALL SHIPS TX/RX	You have sent / received an all ships call
GROUP TX/RX	You have sent / received a group call
INDIVIDUAL TX/RX	You have either sent a call request to a station to establish contact, or another station has made a call to you to establish contact. The call needs a reply.
TEST TX/RX	You either have sent a SAFETY TEST call or have received a SAFETY TEST call from another station that needs to be replied.
POSITION TX/RX	A position request was either sent or received.

Soft keys to control DSC sessions

Call/session types vary in control options, and options may also change if a session changes its state. The following table gives an overview of the DSC soft key commands available:

Soft key	Radio function
QUIT	Terminates the DSC session
HOLD	Puts the DSC session hold if it is active (return to other non-DSC functions)
ACTIVE	Activates the DSC session
INFO	Shows details about the DSC call
RESEND	Transmits an identical call if available
NEWCH	Replies with a new channel if an individual call is received with a communication channel specified which is not available in the radio, or the operator decides to change the channel.
UNABLE	Constructs a reply to the caller if an individual call is received which is not compatible with the radio modes.
SILENT	Silences alarms. Any key silences the alarm but this soft key function will do only this.
ACK	Acknowledges a received call request with the suggested parameters.
POS (Own Distress)	A shortcut to own position data information.
PAUSE (Own Distress)	Pauses the automatic repetition of distress transmissions
RESUME (Own Distress)	Resumes automatic repetition of distress transmissions (if paused)

Soft key	Radio function
ANNUL (Cancel Own Distress)	Cancels an inadvertently transmitted distress
CONFIRM (Cancel Own Distress)	Confirms action and proceed sequence, used in cancel distress procedure
INFO (in Cancel Own Distress)	Turns page of text message.
LOG (Received distress)	A filtered version of the log displaying received calls relevant to the current distress event.

See also *Handling a background session* on page 36.

Detail information for DSC sessions (soft key: **INFO**)

A DSC session is updated based on DSC calls received or transmitted. Press the soft key **INFO** to show the details for the current session.

For distress events a sequence of calls may contribute to the complete view and status of the session. Detailed fields for distress are:

Details — Distress	Explanation
DISTR-MMSI	The vessel in distress
NAT	Nature of Distress
LAT	Latitude position of station in distress
LON	Longitude position of station in distress
POS UTC	Time of position
MODE	Communication mode (Simplex/Semi-duplex Telephony supported)

For other session types the soft key function **INFO** typically shows the details from a single call. Detail fields for other calls than distress are:

Details —other calls	Explanation
CALL Type	(on received call) – The call type may be shown on call reception
CAT	Category of the call: Urgency, Safety or Routine
FROM	The initiator of the call
TO	The intended receiver of the call (unless All Ships)
MODE	Communication mode (Simplex/Semi-duplex Telephony supported)
CHANNEL	Subsequent communication channel
LAT	Latitude position returned upon a position request
LON	Longitude position of station in distress
POS UTC	Time of position

Receiving DSC calls

If the radio is IDLE (not engaged in another session) and a DSC call is received the call details are shown on the display. The following options (soft keys) are available:

Soft key	Radio function
ACK (individual)	The call is acknowledged immediately and the radio is afterwards tuned to the communication channel (if any suggested)
OK (group or all ships)	The radio is already tuned to the suggested communication channel (if any suggested). Pressing this button will display the DSC session view.

If the radio is engaged while receiving a DSC call, the call is shown if it was of higher priority (importance for safety or life). Otherwise it is just queued in the DSC call log for later handling (marked as unread).

If the call is displayed the following soft keys appear:

Soft key	Radio function
ACCEPT	If you accept the new incoming call the radio terminates the ongoing session and the session view is initiated for the new call.
LOG	The call is logged in the DSC call log as an unread message.

An envelope symbol  is shown whenever there are unread messages in the DSC log. Unread messages are automatically retrieved from the log as soon the current DSC session is terminated. The call with the highest priority (importance for safety or life) is shown first.

Handling a background session





The equipment is designed with the possibility to control a DSC session simultaneously with a VHF communication session. The sessions can keep track of their session state and the communication channel used.

If a DSC session is put on HOLD it is automatically put in the background (VHF communication display appears on the previous communication channel).

The soft key  is used to toggle between the VHF communication and a DSC session on hold.

The DSC session on hold can receive calls that are pertinent to the session, even when the session is not displayed. If the background receives updates the icon  is shown.

Example: An individual call request has been sent. While waiting for the acknowledgement of the call, communication is engaged on VHF (press the soft key **HOLD** on the DSC session view). The acknowledgement is received from the called station (the icon  is shown). Press the soft key  and **ACTIVE** to engage in the DSC initiated communication.

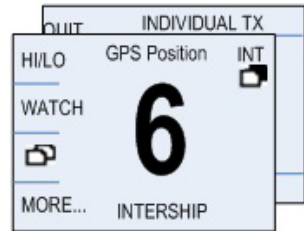

DSC call logs

To display a DSC call log in the **DSC CALL LOGS**, do as follows:

1. Press the soft key **SETUP**. If it is not in the display, press the soft key **MORE** until **SETUP** appears.
2. Press the arrow soft key **➔** or **➜** to advance to **DSC CALL LOGS**.
3. Turn the selector wheel knob to go to a setting, then press the selector wheel knob to view a log.



DSC call log	Description
Received Distress	Shows a log of up to 20 received distress calls.
Transmitted Calls	Shows a log of up to 20 transmitted calls.
Received Calls	Shows a log of all received non distress calls.

Use the soft keys **NEXT** and **PREV** to leaf through all logs.

4. Press **EXIT** to return to normal radio operation.

DSC setup

To change a setting in the **DSC SETUP**, do as follows:

1. Press the soft key **SETUP**. If it is not in the display, press the soft key **MORE** until **SETUP** appears.
2. Press the arrow soft key **➔** or **➜** to advance to **DSC SETUP**.
3. Turn the selector wheel knob to go to a setting, then press the selector wheel knob to change the setting.
4. Press **EXIT** to return to normal radio operation.



DSC setting	Description
Position Info	Available position information. Here you can enter position data, see also <i>Position and MMSI Information</i> on page 8.
Auto-Ack Test	Auto-acknowledgement of test DSC messages OFF - Disabled ON – Enabled (default)
Auto-Ack Individual	Auto acknowledgement of individually addressed, non distress DSC messages OFF - Disabled (default) ON – Enabled
Non-Distr. Inactivity	Inactivity time-out to exit non-distress functions (e.g. in setup) without automatic time-out (OFF): Range: OFF, 1 to 30 minutes, in 1 min. steps Default: 15 min.
Distress Inactivity	Inactivity time-out for received distress DSC automated procedures without automatic time-out: Range: OFF, 1 to 30 minutes, in 1 min. steps Default: OFF
Comm Inactivity	Inactivity time-out of non DSC communication (VHF). Range: 10 to 600 seconds, in 10 s steps Default: 30 s
Non-Distr.Alarms	Non-distress DSC alarms OFF : Disabled ON : Enabled (default)

DSC setting	Description
Auto-switch Channel	Enable automatic channel switching on reception of DSC calls with subsequent communication channel information, while the radio is not engaged (for calls other than individual station calls of category distress or urgency). ON (default) OFF - LCK icon indicates that the channel is locked and must be selected manually
DSC Self Test	You can set the radio to run a DSC self test. OFF : Disabled (default) RUN : Run test. For further details about this test see <i>DSC routine testing</i> on page 70.

Phone book

Use the phone book when making a DSC call. You can enter up to 50 contacts. A contact has the following details:

- Name (up to 20 characters)
- Type (SHIP, GROUP or COAST STATION)
- MMSI number
- Channel
- Position Auto Acknowledge (yes or no) or Listen to Group

The phone book is always sorted alphabetically by contact names. Use the soft key **FILTER** to toggle between CONTACTS - ALL, COAST, SHIP or GROUP. After having selected a contact, the phone book closes automatically.

Using the phone book to make a DSC call

To call a contact using the phone book do as follows:

1. Press the soft key **CALL**. If it is not in the display, press the soft key **MORE** until **CALL** appears. The DSC call composer is shown in the display.
2. Press the soft key **PHBOOK**.
3. Turn the selector wheel knob to scroll to the phone book entry that you want to call.
4. Press the selector wheel knob to select the contact.
5. Press the soft key **SEND** to make the call.

Adding a contact to the phone book

To add a contact to the phone book do as follows:

1. Press the soft key **PHBOOK**. If it is not in the display, press the soft key **MORE** until **PHBOOK** appears in the display.
2. Press the soft key **ADD**.
3. Press the selector wheel knob to enter the **<Name>** field.
Enter the name by turning the selector wheel knob to the desired letter, press the selector wheel knob to accept the letter and advance to the next letter. To finish press the soft key **OK**.
4. Press and turn the selector wheel knob to select the **Type**: SHIP, GROUP or COAST STATION.
5. **MMSI**: Turn and press the selector wheel knob to enter the contact's MMSI number (9 digits), press the soft key **OK** to accept.
6. **CHAN** (optional): Press and turn the selector wheel knob to select the preferred channel for this contact, press the soft key **OK**.
7. **Position Auto Ack** (for Type SHIP or COAST STATION): Press and turn the selector wheel knob to select YES or NO for this contact, press the soft key **OK**. This will allow auto-ack of position requests for this contact.
or:
Listen to Group (for Type GROUP): Press and turn the selector wheel knob to select YES or NO for this contact, press the soft key **OK**. The radio will respond to calls to the specified group.
8. Press the soft key **SAVE** to save the contact information.
9. Press **EXIT** to leave the phone book and return to VHF operation.

Editing a contact

1. Press the soft key **PHBOOK**. If it is not in the display, press the soft key **MORE** until **PHBOOK** appears.
2. Press the soft key **EDIT**.
3. Press and turn the selector wheel knob to browse through the details of the contact.
4. Continue as described in *Adding a contact to the phone book* from step 2 onwards.

Deleting a contact

1. Press the soft key **PHBOOK**. If it is not in the display, press the soft key **MORE** until **PHBOOK** appears.
2. Turn the selector wheel knob to browse to the contact you want to delete.
3. Press the soft key **MORE** until **DELETE** appears.
4. Press the soft key **DELETE**.
5. Press **EXIT** to leave the phone book and return to VHF operation.



Loudhailer with talk-back

The SAILOR 6216 VHF DSC supports a loudhailer with a talk-back function.

Important

When the hailer is in talk-back mode and a radio signal is received, the radio signal has a higher priority and is heard in the loudspeaker.

To activate the loudhailer do as follows:

1. Press the soft key **HAIL**. If it is not in the display, press the soft key **MORE** until **HAIL** appears. 
2. Press **PTT** on the speaking device to activate the **HAILER**. 
3. To change the receiving radio channel, turn the selector wheel knob.
4. To adjust the HAIL volume press the **PTT** button and turn the volume knob.
5. Press the soft key **EXIT** to leave the hailer function.

Using the hailer with talk-back

While in hailer mode the hailer can also be used as a microphone. For details how to set the talk-back mode see *Hailer and Fog horn setup* on page 47. Once set up talk-back is activated when you are in hailer mode and the PTT button is released. 

When talk-back is active your crew can talk to you via the loudhailer horn unit into the loudspeakers. The talk-back volume can be independently adjusted on the volume knob while talk-back is active (TB Volume). If a signal is received on the radio while in talk-back mode, the received radio signal will be heard in the speakers. The received radio signal will be reproduced with the normal volume level.

Automatic foghorn

The SAILOR 6216 VHF DSC has an automatic fog horn application with several foghorn patterns. Once started, it runs in the background while running any other application. The fog horn may be combined with the loudhailer talk-back mode. When the fog horn is activated, the text **FOG** is shown in the top right corner of the display.

Important

Loudhailer talk-back may be active between foghorn emissions. See *Hailer and Fog horn setup* on page 47.

The "TB" symbol is shown in the display if Foghorn talk-back is selected and the automatic foghorn is activated.

The foghorn patterns are fixed and sent out as whistle blasts or as a bell pattern. The tone frequency can be set in the foghorn setup menu.

To activate the foghorn do as follows:

1. Press the soft key **FOG**. If it is not in the display, press the soft key **MORE** until **FOG** appears.

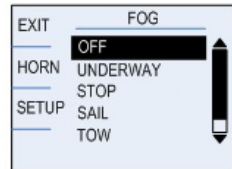

2. Use the selector wheel knob to browse through the patterns available.

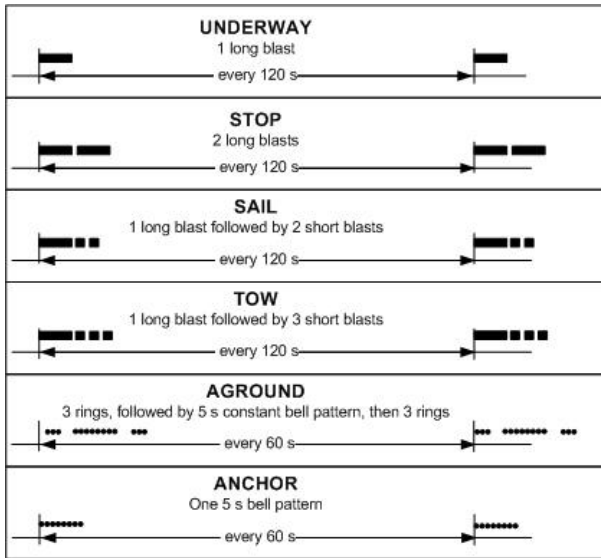

3. Press the selector wheel knob at the wanted pattern to accept the pattern.
4. To deactivate the foghorn, turn the selector wheel knob to browse to **OFF** and press the selector wheel knob.

Foghorn test tone

To manually control that the foghorn produces a blast tone, do as follows:



The **HORN** key appears when no active fog pattern is emitted (OFF). Press and hold the soft key **HORN** to activate the blast tone and adjust the volume of the foghorn by turning the volume wheel knob.



Hailer and Fog horn setup



To change a setting in the **HAILER/FOGHORN SETUP**, do as follows:

1. Press the soft key **SETUP**. If it is not in the display, press the soft key **MORE** until **SETUP** appears.
2. Press the arrow soft key  or  to advance to **HAILER/FOGHORN SETUP**.
3. Turn the selector wheel knob to go to a setting, then press the selector wheel knob to change the setting.
4. Press **EXIT** to return to normal radio operation.



Parameter	Settings
Hailer Talk-back	OFF - Talk back is disabled (Default). ON - Talk back is enabled when listening in the hailer PA mode.
Foghorn Talk-back	OFF - Talk back is disabled if the periodic foghorn is activated.(Default) ON - Talk back is enabled if the periodic foghorn is activated, talk back between horn emissions.
Foghorn Freq.	Adjust the foghorn frequency, allowed range: 200-850 Hz.

Replay function

Replay allows the operator to playback received voice messages in the loudspeaker.

Recording is activated automatically when a signal is received. Recording is not possible during playback. Up to 60 tracks or 90 seconds can be handled.

The recorded channel is displayed. The message length is shown in seconds. The display shows how old the message is. If the 90 s storage limit is reached, the oldest data is overwritten.

Replaying recorded messages

To replay a message do as follows:

1. Press the Replay button (short press). The latest message (message) is repeated. Information about this message is shown in the display.
2. To stop replaying the message press the soft key **STOP**.
3. To play the current message again from the start press the Replay button (short press).
4. To track back the series of messages double-press the Replay button (short press) until the desired track is shown. The selected track is played.
5. To track back in time press and hold the Replay button until the desired point in time. All messages up to the newest will be played.



Installation

In this chapter you find information and guidelines for:

- *Unpacking the SAILOR 6216 VHF DSC*
- *Installing the VHF radio*
- *Power, VHF antenna and external equipment*

Unpacking the SAILOR 6216 VHF DSC

The following items are included in the delivery of a SAILOR 6216 VHF DSC:

- SAILOR 6216 VHF DSC
- SAILOR 6202 Handmicrophone with spiral cable
- User and installation manual (this manual)
- Installation guide
- Mounting bracket with two wheel knobs
- Connectors for cables
- Power cables, fittings and fuses
- Packaging material
- Sun screen (click-on) for front plate protection
- Kit for flush mount installation, including gasket

Installing the VHF radio

You can mount the VHF radio as a desktop, overhead or flush-mounted unit integrated in the instrument panel.

Provide space enough to access the front panel connectors and for installing a cradle for the speaking device.

Provide **at least 120 mm space at the back** of the SAILOR 6216 VHF DSC radio to allow free air circulation.

Compass safe distance

Make sure that the VHF radio is far enough from any magnetic compass to avoid influence of the loudspeaker magnet on the compass reading. See the following table for the safe distance after magnetization between the nearest point of the device and the centre of the compass at which it will produce a deviation of 0.3°.

Device	Safe distance
SAILOR 6216 VHF DSC	1.0 m
SAILOR 6202 Handmicrophone	0.8 m
SAILOR 6209 Accessory Connection Box (optional)	0.6 m

SAILOR 6216 VHF DSC with U mounting bracket

The mounting bracket and two knobs are included in the delivery.

Desktop mounting

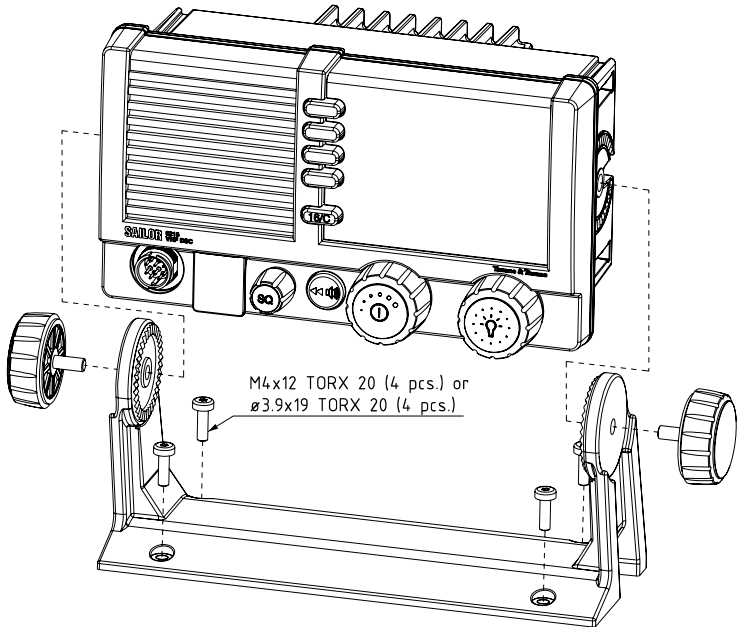

Overhead mounting

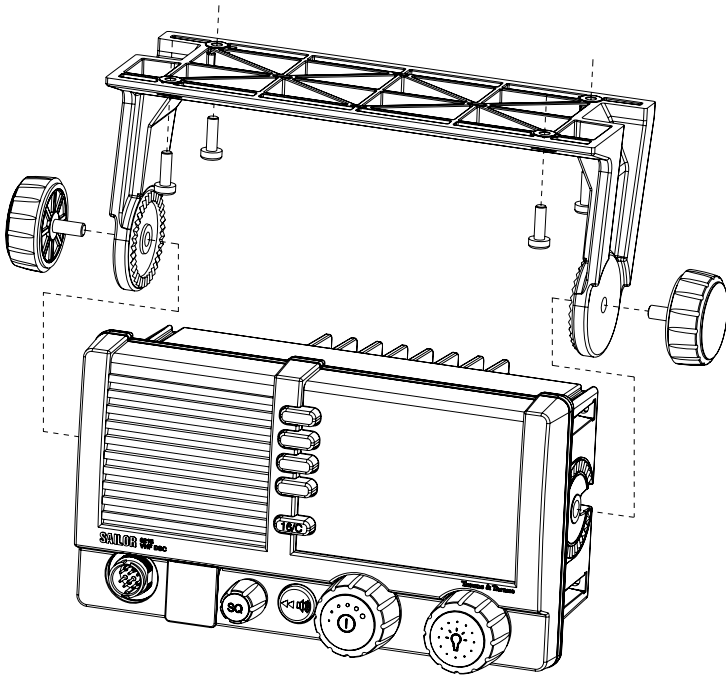

Mounting with U mounting bracket

To mount the VHF radio as tabletop, do as follows:

1. Find a suitable location for the VHF radio. Check that the space is wide/deep enough to accommodate the VHF radio.
2. Fasten the bracket with 4 screws (included in the delivery.)
3. Insert the VHF radio in the bracket and fasten it with the two knobs.
4. The display of the VHF radio should be at an angle of approximately 90° to your line of sight when operating it.

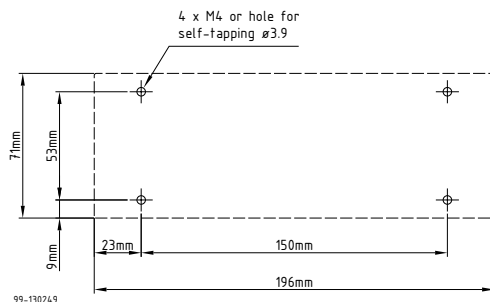
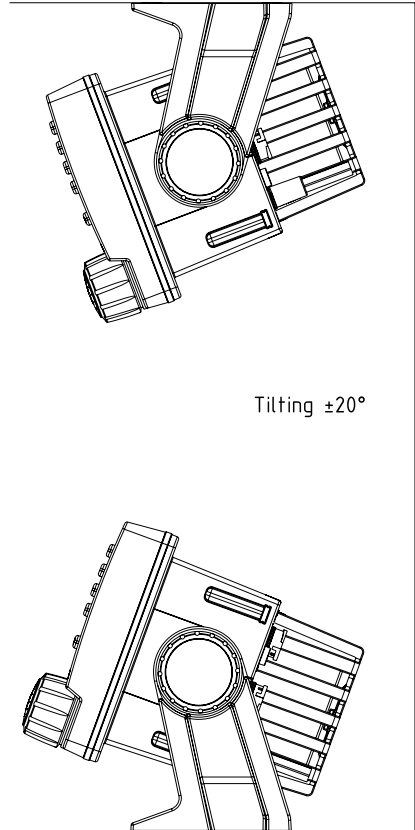

SAILOR 6216 VHF DSC for flush mount

You can mount the VHF radio to a flat surface, e.g. an instrument panel. The flush mount installation kit is included in the delivery.

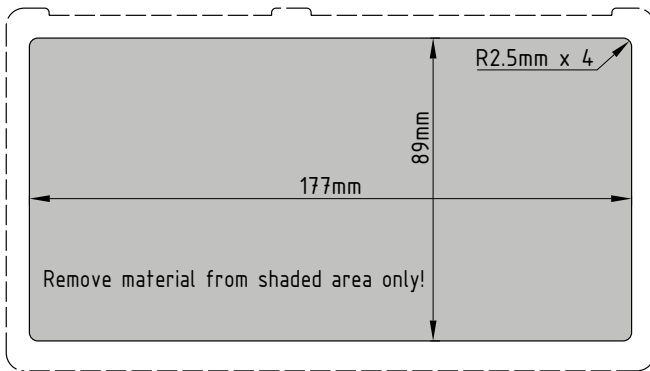
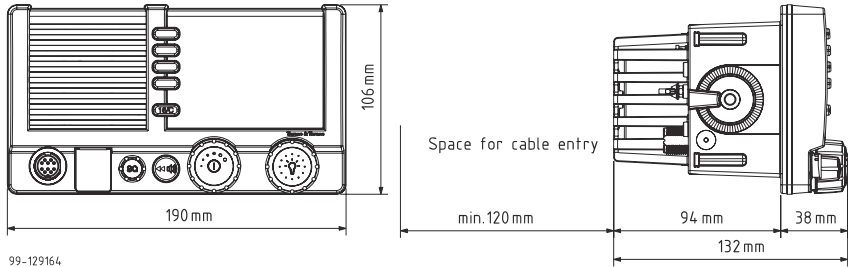

Important

The scaling in the above drawing is not 1:1. Consequently do not attempt to use a print or copy of this page without checking the dimensions.

1. Find a suitable location for the VHF radio. Check that the space is deep enough to accommodate the VHF radio and an additional min. 120 mm space for cable entry.

2. Keep free distance to allow free air circulation around the VHF radio and to allow sufficient space for access to cables, see the drawing on this page.
3. Cut out the hole for the VHF radio where you want to mount it. Use the cutting template in the installation guide.
4. Mount the 4 square nuts M4 in the cabinet, ensure that they are placed correctly so it is possible to screw in the M4x45 screws.
5. Ensure that the flush mount gasket is placed correctly on the VHF radio.
6. Before mounting the VHF radio be aware that the surface is plane and rigid. If the surface is not plane and/or rigid (stiff) remove the gasket and seal with silicone sealant between the VHF radio and the surface.
7. Slide the VHF radio in the cut-out. Place the flush mount bracket and fasten it with the 4 screws M4x45. Make sure the torque does not exceed 1Nm when fastening the screws.

Note | Only use screws supplied with the kit for flush mounting.

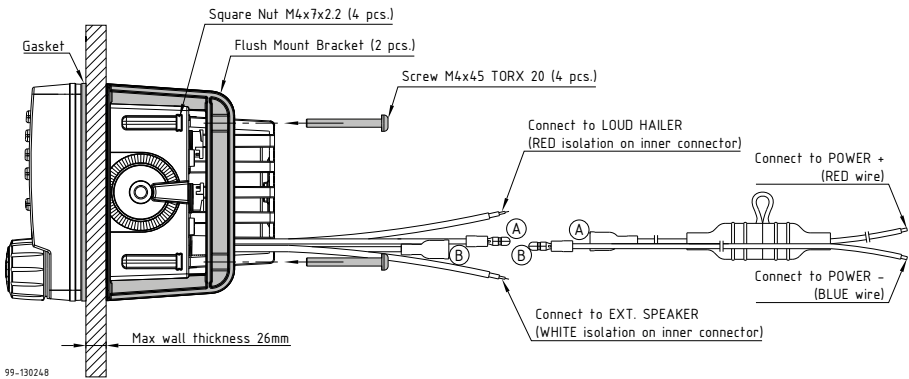

Note | Firmly tie back and secure any wires not used to avoid the possibility for mutual shorting or shorting to ground.

SAILOR 6202 Handmicrophone

Handmicrophone with spiral cable and PTT button.

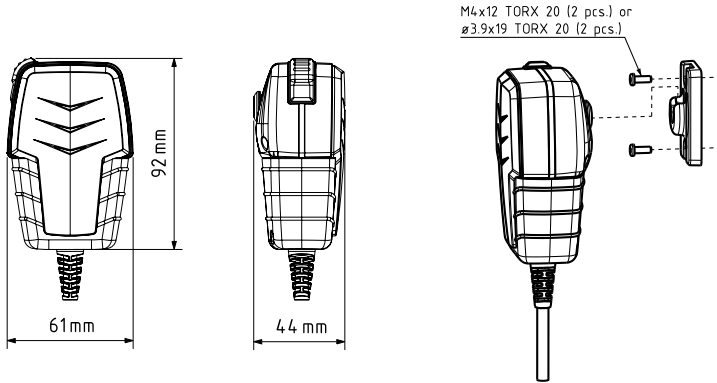

Power, VHF antenna and external equipment

1. ACC connector for accessories
2. CTRL connector for control speaker microphone
3. Power, Loudhailer, foghorn and external speaker
4. VHF antenna
5. Ground stud

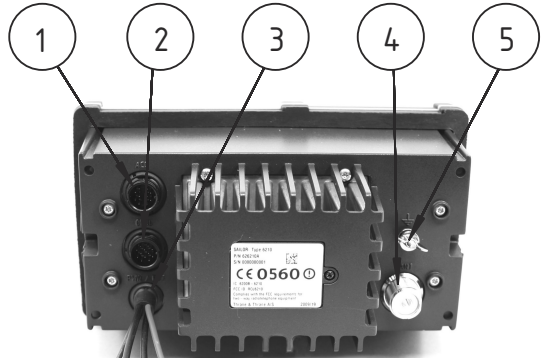

ACC connector

Use the connector marked **ACC** to connect GPS input.

The interface for GPS is NMEA 0183 (EN61 162-1 NMEA0183/ EN61 162-2 NMEA0183 Highspeed).

Connector type: Circular connector, 10pin.

Connection cable with plug, part number 406209-941.

Pin assignment: Connector front view on the VHF radio.

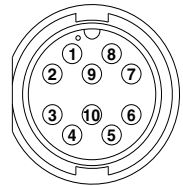

Pin	Description	Wire color
1	NMEA in+	Brown
2	NMEA in-	Blue
3	NMEA out-	White

Pin	Description	Wire color
4	NMEA out+	Green
5	Mike 2	Yellow
6	EAR 2	Grey
7	Hook_PTT	Pink
8	Battery supply when radio is on	Red
9	Internal GND = - Battery	Black
10	Internal GND = - Battery	Orange — SCREEN (Drain)

NMEA interface description

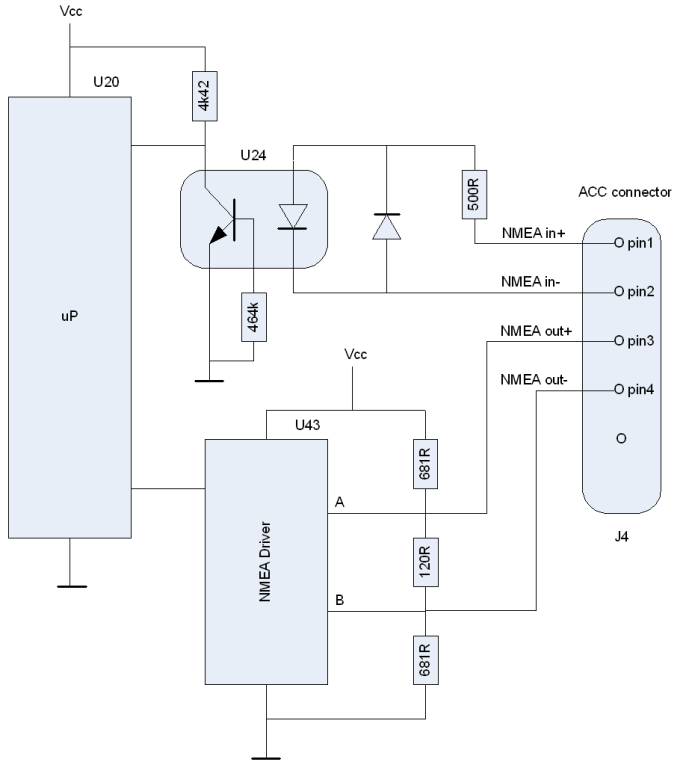

NMEA interface	Specifications
NMEA input:	Impedance: 600 Ohm Max. 2mA at min. level of 2V
NMEA output	Load Impedance: > 60 Ohm Drive load: < 35 mA

The NMEA interface supports NMEA 0183 v2.0, v2.1 and v2.3.

The following sentences are supported:

- FSI: All fields are decoded.
- GGA: UTC, "Position", "quality indicator" (indicators 1-5). All other fields are unused.
- GLL: UTC, "Position", "Status" and "mode" (indicators A and D). All other fields are unused.
- GNS: UTC, "Position" and "mode" (indicators A and D). All other fields are unused.
- RMC: UTC, "Position", "Status", "Date" and "mode" (indicators A and D). All other fields are unused.
- ZDA: UTC, "Day", "Month", and "Year". All other fields are unused.

In accordance with the standard EN61162-1:2008 and EN61162-2:1998

Received NMEA sentences except for FSI can be forwarded to NMEA output. As talker the sentences are streamed when received (with no intervals).

HW revision: 57-127368-D.02

SW revision: 2.00.01

CTRL connector for control speaker microphone

Connector type: Circular connector, 12pin.

Pin assignment: Connector front view on the VHF radio:

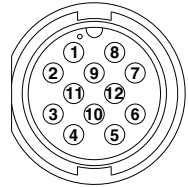

Pin	Description	Pin	Description
1	GND for cable screen	7	Internal GND = - Battery
2	Internal GND = - Battery	8	not used
3	Battery supply when radio is on	9	RX out +
4	Battery supply when radio is on	10	RX out -
5	CAN+	11	TX in +
6	CAN-	12	TX in -

Power, Loudhailer, foghorn and external speaker

Use the connector marked **PWR/EXT** to connect power, loudhailer and an external speaker. The cable for this connector is part of the delivery.

1. Blue wire: Power -
2. Red isolation on inner connector: loudhailer
3. White isolation on inner connector: external speaker
4. Red wire: Power +

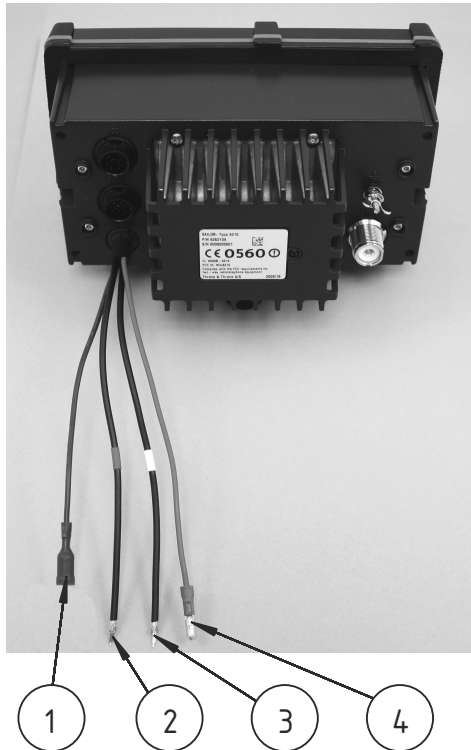

Protection against water ingress

Important

You must protect the cable connection with rubber vulcanizing tape as shown in the pictures below. This protection prevents water seeping into the VHF radio, cable and connectors.

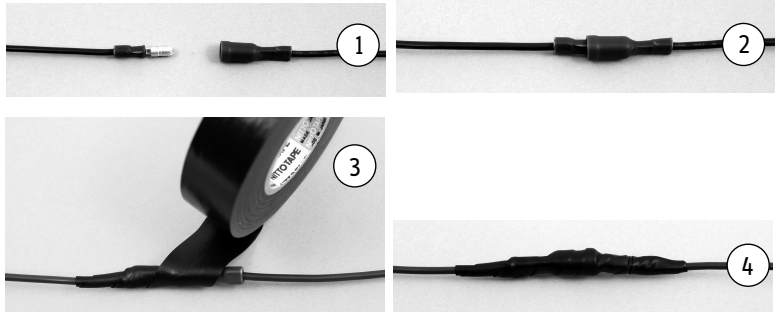

VHF antenna

Use the connector marked **ANT** to connect the VHF antenna to the radio with a 50 Ohm coaxial cable with low loss, e.g. RG214. Install a PL259 plug at the cable end.

Place the antenna as high and clear of obstructions as possible. Make sure that the horizontal distance to metal parts is minimum 1.5 m (5 ft).

Connector type: female SO239 for PL259 plug.

Ground stud

To ground the radio connect a ground wire from the ground stud of the radio to a suitable grounding point. Use an appropriately sized wire. The ground stud is located above the VHF antenna connector.



System setup

To change a setting in the **SYSTEM SETUP**, do as follows:

1. Press the soft key **SETUP**. If it is not in the display, press the soft key **MORE** until **SETUP** appears.
2. Press the arrow soft key **➔** or **➜** to advance to **SYSTEM SETUP**.
3. Turn the selector wheel knob to go to a setting, then press the selector wheel knob to change the setting.
4. Press **EXIT** to return to normal radio operation



SYSTEM SETUP	Description
System time & Date	View and set system time and date
Inactivity timeout	Inactivity time-out to exit functions (e.g. in setup) and return to the application. Range: 1 to 30 minutes, in 1 minute steps Default: 10 min.
NMEA input (baud rate)	4800
Factory Defaults	Resets the radio to factory defaults.
SW version	Software version of the radio
S/N	Serial number of the radio
Password	If you need to change the identity of the radio (MMSI number or ATIS code), contact your local dealer.

SAILOR 6201 Handset cradle (optional)

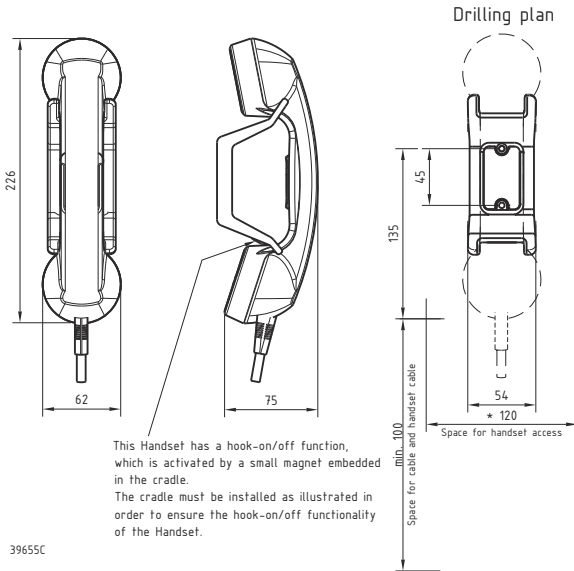

Service & maintenance

Contact for support

Contact your authorized dealer for technical service and support of the VHF radio. Before contacting your authorized dealer you can go through the troubleshooting guide to solve some of the most common operational problems.

Maintenance

Preventive maintenance

Maintenance of the SAILOR 6216 VHF DSC can be reduced to a maintenance check at each visit of the service staff. Inspect the radio for mechanical damages, salt deposits, corrosion and any foreign material. Due to its robust construction and ruggedness the radio has a long lifetime. Anyway it must carefully be checked at intervals not longer than 12 months - dependent on the current working conditions.

Salt deposits

In case the equipment has been exposed to sea water there is a risk of salt crystallization on the keys and wheel knobs and they may become inoperable. Clean the VHF radio and speaker microphones with fresh water.

Error messages and warnings

Errors and warning messages are shown in the display and are read-only.

DSC self test

To run a control routine DSC self test, do as follows:

1. Press the soft key **SETUP**. If it is not in the display, press the soft key **MORE** until **SETUP** appears.
2. Press the arrow soft key **➔** or **➜** to advance to **DSC SETUP**.
3. Turn the selector wheel knob to select **DSC Self Test**. Press and turn the selector wheel knob to select **RUN**.

The test will check the ability to encode/decode DSC signalling on RF level. The radio will automatically transmit a DSC safety test call to its own MMSI number without enabling the transmitter power amplifier. In parallel the radio decodes and compares the received call to be the same as the transmitted.

The display shows the result of the test.

4. Press the soft key **OK** to acknowledge the test result and resume normal operation.

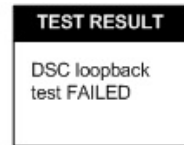
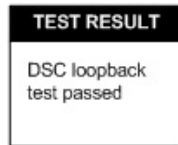

Important

If the DSC loopback test fails, this indicates the DSC functionality does not work correctly — including the ability to send a DISTRESS message.

Contact your dealer immediately for further advice.

Troubleshooting guide

Action	Symptom	Remedy
The radio will not turn on	The display is empty.	<p>Check if power is present.</p> <p>Check fuse which is placed in the + supply wire.</p> <p>Check performance of power supply if connected to one.</p>
No communication	The loudspeaker is mute.	<p>Check the antenna installation.</p> <p>Check antenna cable.</p> <p>Check handset/Handmicrophone and cable.</p>
GPS	Position requested.	<p>If the VHF, despite being connected to a GPS/position source, prompts for entering the position and time information, the automated update has most likely been lost either due to missing data on the line, broken cabling or the GPS/position source has failed. Refer to the installation section in the back of this manual for installation and connection details.</p> <p>Until the automatic position update from GPS/position source is restored position and time must be entered manually when prompted by a (four hour) timer in VHF.</p> <p>In the DSC SETUP, Position Info, you can verify the position data. If data is present Lat/Lon/UTC will be displayed.</p>

Action	Symptom	Remedy
DSC routine testing		<p>Check the DSC function regularly. Verify the complete DSC installation, with antennas, by transmitting a Safety Test call to another station (coast or ship). The test call is generated using the DSC call flow via menu CALL.</p> <p>The call should normally be replied by the receiving station without questioning. The default configuration of a DSC VHF radio is auto-acknowledgement of any received Safety test call requests. If a ship is equipped with multiple radios a second radio can be the station to check up against. The transmitting radio will not receive its own transmitted calls.</p> <p>If there is only a single radio on a vessel, a facility is built into the unit where the DSC engine can be verified using a test call that is internally looped without activating the radio transmitter PA. The test is executed via menu SETUP, DSC SETUP. The call sequence that is verified, is an Individual Safety Test Call directed to own MMSI. The test status is read in the display.</p>
Missing MMSI	DSC operation is not working	<p>When powering up the VHF for the first time after leaving factory there is no MMSI number in the VHF radio. For the DSC operation to function the MMSI number must be entered in the VHF radio. For further details see <i>Entering the MMSI number</i> on page 7.</p>

Action	Symptom	Remedy
Radio time	DSC logs are sorted with wrong time stamp or radio time is incorrect	<p>A wrong radio time indication should occur only if GPS position source is not connected or providing correct time data. A valid GPS time signal will update the UTC time used for time stamping the DSC logs.</p> <p>If a GPS/position source is not connected to the VHF radio and hence position and time is entered manually, you must enter the "radio time" also manually, at least after power up. This will ensure correct time stamping of the DSC logs.</p> <p>The UTC time is the suggested time to be entered when prompted for entering position and time manually (every four hours).</p>
DSC Channel not free	DSC transmission delayed	The transmission of a DSC call which is not of category distress or urgency will be postponed if the VHF radio is in the process of decoding an incoming DSC call. As soon as this decoding process has finalized the transmission will take place.
Handset configuration	No sound in earpiece	The earpiece volume may be configured to OFF. See section <i>Controller setup</i> on page 10 on how to adjust the earpiece volume of the handset.

Action	Symptom	Remedy
Device failure		<p>If any of the checks and tests described in this section do not assist in resolving the difficulties experienced in the operation and/or performance of the VHF installation, a fault may have developed in the VHF radio itself.</p> <p>When contacting an authorized Thrane & Thrane representative be sure to provide as much information as possible describing the observed behavior - also including the type of the VHF radio, its serial number, and software release version (both found in the setup menu Controller Setup).</p>

Replacing the fuse in the red wire (Power +)

One fuse is installed in the supplied DC cable. If the fuse is blown, track down why the fuse was blown and solve the problem. To replace the fuse, do as follows:

1. Hold both ends of the fuse holder and pull it apart.
2. Take out the old fuse.
3. Insert the new fuse. The fuse rating is 10 A T.
4. Make sure that the fuse is tightly fixed on the metal contact inside the fuse holder.
5. Put together the fuse holder.



Equipment and accessories

SAILOR 6209 Accessory connection box

You can use the SAILOR 6209 Accessory Connection Box to combine GPS (NMEA), GPS/AIS DSC modem and the SAILOR 6201 Handset option.

The wire terminal blocks are connected in parallel.

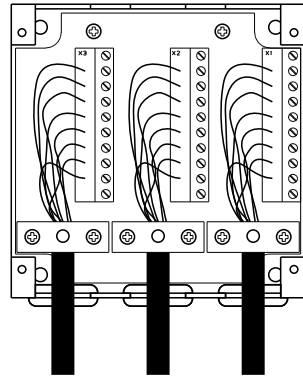

.36090

Warranty

For repair or replacement of the VHF radio within terms of warranty, contact your local dealer.

Technical specifications

Item	Specification
Weight SAILOR 6216 VHF DSC	approx. 1.2 kg 2,65 lbs
Weight SAILOR 6216 VHF DSC and Handmicrophone	approx. 1,5 kg 3,31 lbs including SAILOR 6202 Handmicrophone and mounting bracket
Dimensions	<p>Height: Outer dimension 106 mm, hole height for flush mount 89 mm</p> <p>Width: Outer dimension 190 mm, hole width for flush mount 177 mm</p> <p>Depth: Outer dimension from front of wheel knobs 132 mm, depth for flush mount 94 mm</p>
Operating temperature	-15°C to 55°C 5°F to 131°F
Storage temperature	-30°C to 80°C -22°F to 176°F
Power supply	12 VDC Nominal (10,8– 15,6 VDC)
Current consumption	Max. 7 A
Frequency range	TX 156,000-161,450, RX 156,000-163.425 MHz
Channel spacing	12,5 kHz and 25 kHz, all international maritime channels

Appendix A: Technical specifications

Item	Specification
Number of P channels	The radio may be programmed with up to 40 private channels that can be managed in all channel modes.
Transmit power	Hi/Lo: 25 W and <1 W
RF output power	25 W +0 dB / - 1.5 dB 1 W +0 dB / - 1.5 dB
RF output power, Canada	21 W \pm 0.75 dB / 0.8 W \pm 0.75 dB
Modulation 25 kHz 12.5 kHz	16K0G3E, 16K0G2B (DSC) 8K05G3E
LF power	Built-in loudspeaker: 6 W External loudspeaker: 6 W / 8 Ohm Loudhailer: 30 W / 4 Ohm (when the unit is not transmitting)
Receiver sensitivity	< -119 dBm typically @ 20 dB SINAD CCITT weighted
Antenna	50 Ohm antenna, 50 Ohm female SO239 for PL259 plug 1-antenna operation for VHF and DSC communication
Water ingress	IPx8 and IPx6 all over. For flush-mount installations a sealing gasket is included in the delivery.

NMEA data rates and formats

Item	Value
62162-1	4800,8,n,1 (in/out)
62162-2	38400,8,n,1 (out only)

Maritime channels

International channels

Channels	TX MHz	RX MHz	SIMPLEX		DUPLEX	
			Intership	Port	Port	Public
1	156,050	160,650			●	●
2	156,100	160,700			●	●
3	156,150	160,750			●	●
4	156,200	160,800			●	●
5	156,250	160,850			●	●
6	156,300	156,300	●			
7	156,350	160,950			●	●
8	156,400	156,400	●			
9	156,450	156,450	●	●		
10	156,500	156,500	●	●		
11	156,550	156,550	●	●		
12	156,600	156,600		●		
13	156,650	156,650	●	●		
14	156,700	156,700		●		
15	156,750	156,750	●	●		
16	156,800	156,800	Distress and calling			
17	156,850	156,850	●	●		
18	156,900	161,500			●	●
19	156,950	161,550			●	●
20	157,000	161,600			●	●
21	157,050	161,650			●	●
22	157,100	161,700			●	●
23	157,150	161,750			●	●
24	157,200	161,800			●	●
25	157,250	161,850			●	●
26	157,300	161,900			●	●
27	157,350	161,950			●	●
28	157,400	162,000			●	●

Channels	TX MHz	RX MHz	SIMPLEX		DUPLEX	
			Intership	Port	Port	Public
60	156,025	160,625			●	●
61	156,075	160,675			●	●
62	156,125	160,725			●	●
63	156,175	160,775			●	●
64	156,225	160,825			●	●
65	156,275	160,875			●	●
66	156,325	160,925			●	●
67	156,375	156,375	●	●		
68	156,425	156,425		●		
69	156,475	156,475		●		
70	156,525	156,525	DSC	DSC		
71	156,575	156,575		●		
72	156,625	156,625	●	●		
73	156,675	156,675	●	●		
74	156,725	156,725		●		
75	156,775	156,775		● L)		
76	156,825	156,825		● L)		
77	156,875	156,875	●			
78	156,925	161,525			●	●
79	156,975	161,575			●	●
80	157,025	161,625			●	●
81	157,075	161,675			●	●
82	157,125	161,725			●	●
83	157,175	161,775			●	●
84	157,225	161,825			●	●
85	157,275	161,875			●	●
86	157,325	161,925			●	●
87	157,375	157,375		● *)		
88	157,425	157,425		● *)		

L) 1 W TX power

*) Channel 87 and 88 became simplex channels following the introduction of AIS1 at 161.975 MHz and AIS2 on 162.025 MHz.

These are the default channels. Additional narrowband channels can be enabled, see *Radio setup* on page 21.

US channels

Channels	TX MHz	RX MHz	SIMPLEX	DUPLEX
1A	156.050	156.050	●	
2				B)
3				B)
4				B)
5A	156.250	156.250	●	
6	156.300	156.300	●	
7A	156.350	156.350	●	
8	156.400	156.400	●	
9	156.450	156.450	●	
10	156.500	156.500	●	
11	156.550	156.550	●	
12	156.600	156.600	●	
13	156.650	156.650	● L)	
14	156.700	156.700	●	
15B		156.750	● RX)	
16	156.800	156.800	Distress and calling	
17	156.850	156.850	●	
18A	156.900	156.900	●	
19A	156.950	156.950	●	
20	157.000	161.600		●
20A	157.000	157.000	●	
21A	157.050	157.050	● I)	
22A	157.100	157.100	● I)	
23A	157.150	157.150	● I)	
24	157.200	161.800		●
25	157.250	161.850		●
26	157.300	161.900		●
27	157.350	161.950		●
28	157.400	162.000		●

Channels	TX MHz	RX MHz	SIMPLEX	DUPLEX
60				B)
61				B)
62				B)
63A	156.175	156.175	●	
64				B)
65A	156.275	156.275	●	
66A	156.325	156.325	●	
67	156.375	156.375	● L)	
68	156.425	156.425	●	
69	156.475	156.475	●	
70	156.525	156.525		DSC
71	156.575	156.575	● L)	
72	156.625	156.625	●	
73	156.675	156.675	●	
74	156.725	156.725	●	
75				B)
76				B)
77	156.875	156.875	●	
78A	156.925	156.925	●	
79A	156.975	156.975	●	
80A	157.025	157.025	●	
81A	157.075	157.075	● I)	
82A	157.125	157.125	● I)	
83A	157.175	157.175	● I)	
84	157.225	161.825		●
85	157.275	161.875		●
86	157.325	161.925		●
87A	157.375	157.375	● *)	
88A	157.425	157.425	● *)	

Channels	RX MHz
W1	162.550
W2	162.400
W3	162.475
W4	162.425
W5	162.450
W6	162.500
W7	162.525

- L) 1 W TX power. Channels 13, 67 and 77 are limited to low transmission power.
- B) Channels 2, 3, 4, 60, 61, 62, 64, 75 and 76 cannot be selected in US mode.
- I) Channels 21A, 22A, 23A, 81A, 82A and 83A may be legally used in some circumstances but not by the general public in US waters.
- RX) Only RX: transmissions are blocked.
- *) Channels 87 and 88 became simplex channels following the introduction of AIS1 at 161.975 MHz and AIS2 on 162.025 MHz.

These are the default channels. Additional narrowband channels can be enabled, see *Radio setup* on page 21.

Ca channels

Channels	TX MHz	RX MHz	SIMPLEX	DUPLEX
1	156,050	160,650		●
2	156,100	160,700		●
3	156,150	160,750		●
4A	156,200	156,200	● I)	
5A	156,250	156,250	●	
6	156,300	156,300	● I)	
7A	156,350	156,350	●	
8	156,400	156,400	●	
9	156,450	156,450	●	
10	156,500	156,500	●	
11	156,550	156,550	●	
12	156,600	156,600	●	
13	156,650	156,650	●	
14	156,700	156,700	● L)	
15	156,750	156,750	●	
16	156,800	156,800	●	
17	156,850	156,850	● L)	
Distress and calling				
18A	156,900	156,900	●	
19A	156,950	156,950	● I)	
20	157,000	161,600	●	● L)
21A	157,050	157,050	● I)	
21B		161,650	● RX)	
22A	157,100	157,100	● I)	
23	157,150	161,750		●
24	157,200	161,800		●
25	157,250	161,850		●
26	157,300	161,900		●
27	157,350	161,950		●
28	157,400	162,000		●

Channels	TX MHz	RX MHz	SIMPLEX	DUPLEX
60	156,025	160,625		●
61A	156,075	156,075	● I)	
62A	156,125	156,125	● I)	
63A	156,175	156,175	● I)	
64	156,225	160,825		●
64A	156,225	156,225	●	
65A	156,275	156,275	● L)	
66A	156,325	156,325	● L)	
67	156,375	156,375	● I)	
68	156,425	156,425	●	
69	156,475	156,475	●	
70	156,525	156,525	●	
71	156,575	156,575	●	
72	156,625	156,625	● I)	
73	156,675	156,675	● I)	
74	156,725	156,725	●	
75	156,775	156,775	● L)	
76	156,825	156,825	● L)	
77	156,875	156,875	● L)	
78A	156,925	156,925	●	
79A	156,975	156,975	●	
80A	157,025	157,025	●	
81A	157,075	157,075	● I)	
82A	157,125	157,125	● I)	
83A	157,175	157,175	● I)	
83B		161,775	● RX)	
84	157,225	161,825		●
85	157,275	161,875		●
86	157,325	161,925		●
87	157,375	157,375	● *)	
88	157,425	157,425	● *)	

Channels	RX MHz
W1	162,550
W2	162,400
W3	162,475
W4	162,425
W5	162,450
W6	162,500
W7	162,525

Maritime channels

- L) 1 W TX power. Channels 15, 17, 20, 65, 66, 75, 76 and 77 are limited to 1 W transmission power.
- I) Channels 4A, 6, 19A, 21A, 22A, 61A, 62A, 63A, 67, 72, 73, 81A, 82A and 83A may be legally used in some circumstances but not by the general public in CA waters.
- RX) Only RX: transmission is blocked.
- *) Channels 87 and 88 became simplex channels following the introduction of AIS1 at 161.975 MHz and AIS2 on 162.025 MHz.

These are the default channels. Additional narrowband channels can be enabled, see *Radio setup* on page 21.

Bi channels

Channels	TX MHz	RX MHz	SIMPLEX		DUPLEX	
			Intership	Port	Port	Public
1	156.050	160.650			●	●
2	156.100	160.700			●	●
3	156.150	160.750			●	●
4	156.200	160.800			●	●
5	156.250	160.850			●	●
6	156.300	156.300	● L)			
7	156.350	160.950			●	●
8	156.400	156.400	● L)			
9	156.450	156.450	●	●		
10	156.500	156.500	● L)	● L)		
11	156.550	156.550		● L)		
12	156.600	156.600		● L)		
13	156.650	156.650	● L)	● L)		
14	156.700	156.700		● L)		
15	156.750	156.750	● L)	● L)		
16	156.800	156.800	Distress and calling			
17	156.850	156.850	● L)	● L)		
18	156.900	161.500			●	●
19	156.950	161.550			●	●
20	157.000	161.600			●	●
21	157.050	161.650			●	●
22	157.100	161.700			●	●
23	157.150	161.750			●	●
24	157.200	161.800			●	●
25	157.250	161.850			●	●
26	157.300	161.900			●	●
27	157.350	161.950			●	●
28	157.400	162.000			●	●

Channels	TX MHz	RX MHz	SIMPLEX		DUPLEX	
			Intership	Port	Port	Public
60	156.025	160.625			●	●
61	156.075	160.675			●	●
62	156.125	160.725			●	●
63	156.175	160.775			●	●
64	156.225	160.825			●	●
65	156.275	160.875			●	●
66	156.325	160.925			●	●
67	156.375	156.375	●	●		
68	156.425	156.425			●	
69	156.475	156.475	●	●		
70	156.525	156.525	DSC	DSC		
71	156.575	156.575		● L)		
72	156.625	156.625	● L)			
73	156.675	156.675	●	●		
74	156.725	156.725		● L)		
75				● B)		
76				● B)		
77	156.875	156.875	● L)			
78	156.925	161.525			●	●
79	156.975	161.575			●	●
80	157.025	161.625			●	●
81	157.075	161.675			●	●
82	157.125	161.725			●	●
83	157.175	161.775			●	●
84	157.225	161.825			●	●
85	157.275	161.875			●	●
86	157.325	161.925			●	●
87	157.375	157.375		● *)		
88	157.425	157.425		● *)		

- L) 1 W TX power on channels 6, 8, 10, 11, 12, 13, 14, 15, 17, 71, 72, 74 and 77.
- B) Channels 75 and 76 cannot be selected in BI mode.
- *) Channels 87 and 88 became simplex channels following the introduction of AIS1 at 161.975 MHz and AIS2 on 162.025 MHz.

NB! The ATIS function is enabled on all channels.
Dual Watch & Scanning modes are disabled.

Alternative channels

If the radio is used in regions where neither of the four described standard channels are allowed, a reduced channel table with international channel designators and frequencies can be made. Contact your local dealer for programming the alternative channels.

Private channels

Up to 40 licensed private channels for non-DSC purposes may be specified. For programming the private channels contact your local dealer.

A

ACC Accessories

AIS Automatic Identification System, a short range coastal tracking system used on ships and by Vessel Traffic Services for identifying and locating vessels by electronically exchanging data with other nearby ships.

ATIS Automatic Transmission Identification System

C

CTRL Control

D

DSC Digital Selective Calling

E

EXT External

G

GGA NMEA sentence, essential fix data which provide 3D location and accuracy data.

GLL NMEA sentence, Geographic Latitude and Longitude

GNS NMEA sentence,

GPS Global Positioning System

N

NMEA National Marine Electronics Association, specification for communication between marine electronic devices

P

PTT Push To Talk

PWR Power

R

RMC NMEA sentence, version of essential gps position, velocity, time data.

U

UTC Coordinated Universal Time. The International Atomic Time (TAI) with leap seconds added at irregular intervals to compensate for the Earth's slowing rotation. Leap seconds are used to allow UTC to closely track UT1, which is mean solar time at the Royal Observatory, Greenwich.

V

VHF Very High Frequency

Z

ZDA NMEA sentence, date and time.

Numerics

- 16/C, 12
- 90 s replay, 48

A

- ACC connector, 57
- accessories, 74
- acknowledgement, distress, 26
- action line, display, 3
- activate
 - foghorn, 41, 45
 - scan resume, 21
 - scanning, 19
 - watch, 18
- ADD, 42
- add a contact, 42
- adjust
 - squelch, 9
- adjusting
 - speaker volume, 6
- ALT, 82
- ALT channel table, 22
- ANT connector, 63
- ATIS code, 23
 - change, 64
- attenuation control, 17
- Auto-Ack Individual, 39
- Auto-Ack Test, 39
- Auto-switch Channel, 40

B

- background sessions
 - DSC, 36

- backlight, 1
 - dim, 6
- Bi, 82
- Bi channels, 82
- browse channels, 6

C

- Ca channels, 81
- cable for VHF antenna, 63
- CALL, 41
- call
 - Distress procedure, iv
 - DSC, 24
- call channel, program, 15
- call log, DSC, 38
- CAN channel table, 22
- cancelling
 - distress, 27
- change
 - dual and triple watch, 18
- channel
 - add to scan, 19
 - naming, 15
 - program, 15
 - remove from scan, 19
 - select, 6
 - working, 6
- channel table
 - ALT, 22, 82
 - Bi, 82
 - Ca, 81
 - CAN, 22
 - INT, 79
 - PRIV, 22, 82
 - US, 22, 80

channels
 Bi, 82
 Ca, 81
 international, 79
 primary, 14
 private, 14
 US, 80
 weather, 14
Comm Inactivity, 39
compass safe distance, 50
configuration
 system example, 4
connector
 ACC, 57
 ANT, 63
 CTRL, 61
 external speaker, 62
 foghorn, 62
 loudhailer, 62
 VHF antenna, 63
contact, 67
 adding, 42
 deleting, 43
 editing, 43
controls, front plate, 2
cradle for 6201, installation, 65
CTRL connector, 61

D

data rate
 NMEA, 77
deactivate, 46
 foghorn, 46
 watch, 18
default reset, 64
DELETE, 43
delete contact, 43

delivery, items included, 49
dim, 6
display, 3
distress
 acknowledgement, 26
 cancelling, 27
 display, 25
 nature, 25
 power failure, 28
 received calls, 28
 time since activation, 25
distress button, 24
Distress procedure, iv
Distress timeout, 39
document number, this manual, i
DSC
 background sessions, 36
 call log, 29, 38
 calls, 24
 loopback test, 68
 multiple calls, 36
 session definition, 31
 setup, 38
DSC alarms
 non distress, 39
DSC headlines, 32
DSC self test, 40
DSC session, 31
 typical display, 31
DSC setup, 38
DSC soft keys, 33
dual watch, 21
 change to triple, 18

E

editing a contact, 43
emergency calls, iv

enter position manually, 8
error messages, 67
external speaker
 cabling, 62
 connector, 62

F

factory defaults, 64
flush mount, 54
FOG, 45
foghorn, 1, 45, 46
 activate, 41, 45
 connector, 62
 patterns, 1
 test tone, 46
foghorn frequency, setup, 47
frequency range, VHF, 75
front plate, controls, 2
fuses, how to replace, 73

G

GPS data, 8
GPS input, 57, 74
GPS position
 display, 8

H

HAIL, 44
hand microphone
 installing, 56
Handmicrophone, 9
handset cradle
 installation, 65
hang time, 21

headline
 DSC, 32
HORN, 46

I

input
 GPS, 74
 handset, 74
 NMEA, 64
installation
 cradle for 6201, 65
 desktop, 51
 flush mount, 54
 handset cradle, 65
 mounting bracket, 53
 overhead, 52
INT, 79
IP rating, 76

K

key 16/C, 12
keys on front plate, 2

L

LO/HI, 17
LOCAL, 17
loud hailer, 44
 cabling, 62
louder, volume, 6
loudhailer, 1
 connector, 62
 receiving radio channel, 44
low power
 override, 17
low power, overriding, 17

M

- manual, document number, i
- maritime channels, 79
- MAYDAY, iv
- message
 - replay, 48
- MMSI
 - change, 64
- MMSI number
 - reviewing, 8
- MORE, 10
- mounting, 50
 - flush mount, 54
 - with mounting bracket, 53
- multiple calls, DSC, 36
- mute
 - speaker, 9

N

- NAME, 15
- name a call channel, 15
- nature of distress, 25
- night vision, how to dim, 6
- NMEA, 57
 - data rate, 77
- NMEA input, 64
- NMEA interface, 59
- NMEA output, 59
- Non-dist Inactivity, 39
- Non-distr.alarms, 39

O

- overriding low power, 17

P

- PA
 - talk-back, 44
- password, 64
- PHBOOK, 41
- phone book, 41
 - add contact, 42
 - delete a contact, 43
 - edit a contact, 43
- position
 - enter manually, 8
- position data
 - enter manually, 39
- position Info, 39
- power
 - cabling, 62
 - fuse, 73
 - off, 6
 - on, 6
- power failure
 - distress, 28
- primary channel, program, 15
- priority scan, 22
- PRIV, 82
- PRIV channel table, 22
- private channels, 14
- program, call channel, 15
- PTT button, 12

R

- radio call
 - making, 13
 - receiving, 13
- radio channel, loudhailer, 44
- received distress calls, 28

replay, 1, 48
 button, 2
reset to default, 64
resume time, 21
review MMSI number, 8
run
 DSC self test, 40

S

safety summary, iii
salt deposits, 67
scan
 add channel, 19
 hang time, 21
 priority, 22
 remove channel, 19
 resume time, 21
 resume, activate, 21
scanning
 start, 19
selector wheel knob, 2, 6
self test, 68
 DSC, 40
semi duplex, 1
serial number, 64
service line, display, 3
setup
 controller, 10
 DSC, 38
 foghorn frequency, 47
 Radio, 21
 system, 64
 watch, 21
simplex, 1
soft key
 ADD, 42
 CALL, 41
 DELETE, 43
 DSC, 33
 FOG, 45
 HAIL, 44
 HORN, 46
 LOCAL, 17
 MORE, 10
 NAME, 15
 OVRIDE, 17
 PHBOOK, 41
 STOP, 48
 TAG, 19
 WATCH, 18
 WX, 20
soft keys, 9
softer, volume, 6
Software version, 64
speaker volume, 6
speaking devices, 9
specifications, 75
squelch, 9
squelch control, 2, 9
STOP, 48
stop
 replaying a message, 48
 watch or scan, 18, 19
support, 67
SW version, 64
system configuration
 example, 4
system setup, 64

T

- TAG, 19
 - remove, 19
- talk back, 47
- technical data, 75
- temperature
 - operational, 75
 - storage, 75
- testing, foghorn, 46
- time out
 - non distress, 39
- timeout, 64
 - Distress, 39
 - VHF and other non distress, 39
- triple watch, 21
 - change to dual, 18

U

- US, 80
- US channel table, 22, 80
- Use GPS, 8
- UTC time, 3
 - enter manually, 8

V

- VHF
 - antenna cable, 63
 - antenna connector, 63
 - channels, 14
 - frequency range, 75
- volume
 - louder, 6
 - softer, 6
 - speaker, 6
- Volume wheel knob, 2

W

- warnings, 67
- warranty, 74
 - limitation, iii
- WATCH, 18, 19
- watch
 - dual and triple, 18
 - dual or triple, 21
 - setup, 21
 - start, 18
 - stop, 18
- water ingress, 76
- weather channels, 14
- weight, 75
- wheel knob
 - selector, 2
 - volume, 2
- working channel, 6
- WX, 20

